

FOUNDATION

PLATFORM

2018 pricelist

CCN

INTERNATIONAL

About CCN

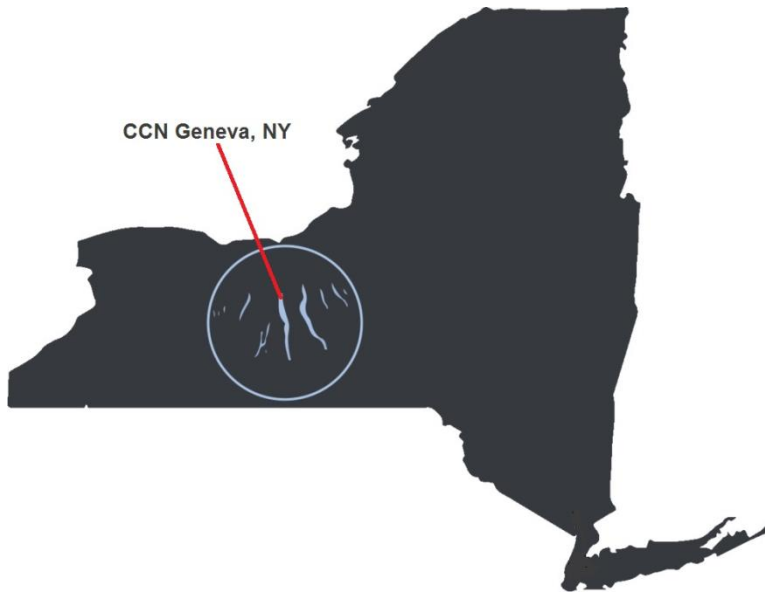

Founded in 1985, CCN merged the talents of partners with a strong foundation in custom/OEM manufacturing and sales/marketing expertise. Concentrating on the manufacture of wood casegoods for corporate and institutional environments, CCN has developed a solid reputation for both innovation and quality. Headquartered in the heart of Upstate New York's Finger Lakes region, CCN benefits from the local heritage of fine woodworking, having been a center for both the American Arts and Crafts movement in the early 1900's and a mecca for the Studio Arts in the 60's and 70's. CCN's manufacturing facility merges state of the art computer controlled machinery with time honored hand craftsmanship, taking full advantage of the best each has to offer.

As more and more and more manufacturers convert to "flat line" componentization (essentially a kit of parts), CCN continues to provide heirloom quality case pieces constructed with mitered and dovetail joinery.

Long respected for the quality and manner in which wood veneer panels are implemented in their furniture, CCN hand selects the highest quality veneers and lays them up in house to ensure the finest results. CCN approaches all orders on a per-project basis, selecting materials specifically for that project, then making certain that all veneer panels are not only sequenced, centered and balanced for each individual piece of furniture, but for the complete order, whether it be one room or fifty.

This expertise in the execution of veneers is complemented by a similar attention to high quality construction, craftsmanship of solid wood elements, state of the art finishes, the integration of other material such as metal or stone. Our ability to accommodate office technology includes sit to stand work surfaces as well as wiring solutions, power/data connections, video lifts, keyless locking, etcetera. Accommodating modifications to standard product has been an integral part of the CCN success strategy from day one.

This overview Price List provides a glimpse of CCN's product scope and capabilities. All product categories are more thoroughly presented on the CCN website. For more on the full breadth of CCN's offerings, information regarding discounts or for product modification inquiries, contact your local CCN representative, our customer service group at 315-789-4400, or visit us on the web at www.ccnintl.com

FOUNDATION

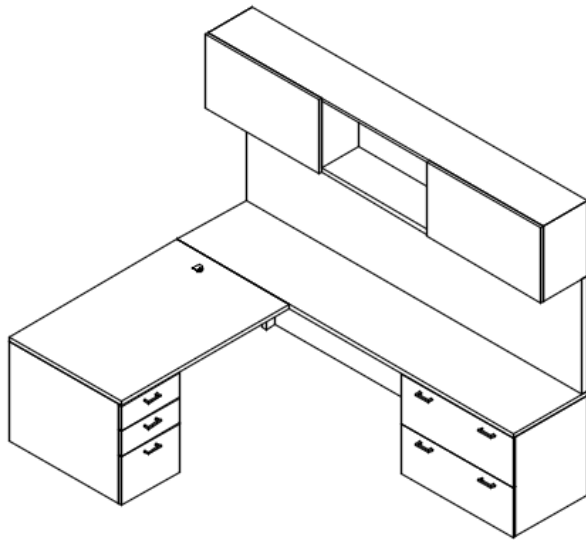

FOUNDATION products feature 1-1/2" thickness full overlay wood tops in conjunction with a variety of wood casepiece components and backwalls. Adjoining worksurfaces are connected via butt joints with concealed alignment tabs and steel mending plates.

CCN's standard finishing system is based on a unique and up to date eco-friendly system of lightfast dyes and high strength pigments. This allows for excellent color matching capabilities while also offering exceptional clarity and high definition of natural character. This finish is then sealed and topcoated with a UV absorbing cross-linked high solids coating which is highly resistant to household chemicals and yellowing as well as being mar resistant.

The underside of worksurfaces and backs of some storage units are "unfinished". Secondary grade veneer, black sealer paper, or a high solids sealer is applied to enhance dimensional stability. Storage units include hi-rises, tall storage, towers, anchors, spanner cabinets, wall hung cabinets, bookcases, pedestals, and lateral files.

Wire access grommets are optional and must be specified along with desired location.

An exit hole is provided in the back of all high-rises to accommodate task light wiring. As a result, tackboards are not required to conceal wiring. The backs of wall hung and spanner storage units are recessed by 3/4" to accommodate wiring as well as concealed wall hanging cleats. Standard tackboard fabric is Gilford Anchorage 2335. COM fabrics will be entertained. .

Standard pulls are rectilinear "loop" configuration in matte silver or polished chrome and are **4-1/8"**x 1-1/8" x 3/8" or **9-1/8"** depending on application.

FOUNDATION

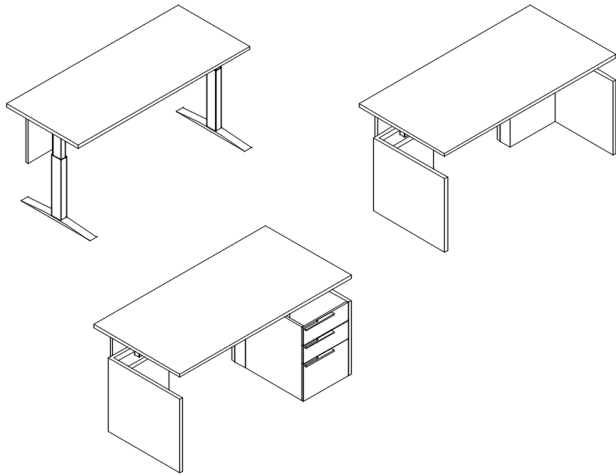

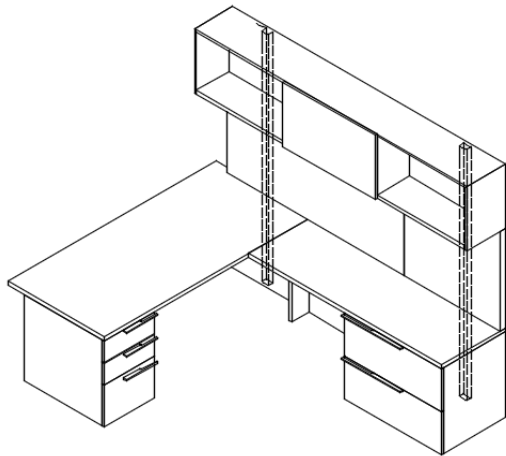

Sit-To-Stand adjustable height worksurfaces can be specified as a freestanding table desk, freestanding desk with one or two pedestals, casegoods integrated into a return, credenza assembly, or a runoff desk that is integrated with a return at one side and freestanding at the other.

Height adjustment range is from 29-1/2" to 45-5/8". A wire management trough and a flexible wire manager are both included, as is a programmable controller.

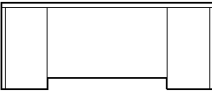
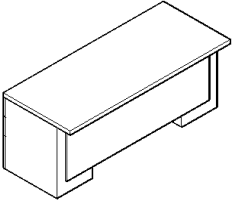

Stanchion-Mounted Overheads utilize concealed steel posts to support overhead cabinets and backwalls, eliminating the requirement for overhead end panels. The result is an appearance of wall mounted overhead cabinetry without the need for blocking within a wall or expensive repair to walls at a later date. Stanchion mounted overheads must be used in conjunction with stanchion mount credenzas. Stanchions posts, hat channels, and fabric clad tackboards are included when ordering stanchion mount overheads.

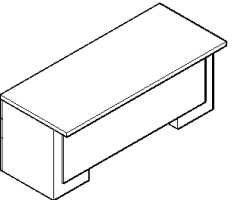
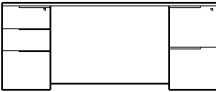
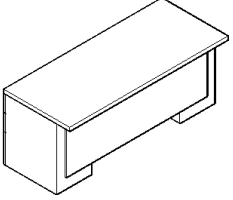
| Description | | Model Number | Depth | Width | Height | Notes | Price (US\$) | Weight (lbs.) | |
|---|--|--------------|-------------|-------|--------|--|--|---------------|-----|
| Pedestal Desk Shell w/ No Pedestals   | | XD0-3066 | 30 | 66 | 29¼ | | 3313 | 177 | |
| | | XD0-3072 | 30 | 72 | 29¼ | | 3446 | 187 | |
| | | XD0-3076 | 30 | 78 | 29¼ | | 3578 | 197 | |
| | | XD0-3084 | 30 | 84 | 29¼ | | 3711 | 207 | |
| | | XD0-3666 | 30 | 66 | 29¼ | | 3529 | 203 | |
| | | XD0-3672 | 30 | 72 | 29¼ | | 3664 | 214 | |
| | | XD0-3678 | 30 | 78 | 29¼ | | 3807 | 225 | |
| | | XD0-3684 | 30 | 84 | 29¼ | | 3946 | 236 | |
| | straight front full overhang | | | | | | | | |
| | Single Pedestal Desk   | | XD0-3066-AR | 30 | 66 | 29¼ | letter width b/b/f ped, 6"overhang | 4260 | 222 |
| | | XD0-3072-CR | 30 | 72 | 29¼ | legal width b/b/f ped, 6"overhang | 4394 | 232 | |
| | | XD0-3078-CR | 30 | 78 | 29¼ | legal width b/b/f ped, 6"overhang | 4522 | 242 | |
| | | XD0-3084-CR | 30 | 84 | 29¼ | legal width b/b/f ped, 6"overhang | 4658 | 252 | |
| | | XD0-3666-AR | 36 | 66 | 29¼ | letter width b/b/f ped, 6"overhang | 4503 | 242 | |
| | | XD0-3672-CR | 36 | 72 | 29¼ | legal width b/b/f ped, 6"overhang | 4638 | 253 | |
| | | XD0-3678-CR | 36 | 78 | 29¼ | legal width b/b/f ped, 6"overhang | 4777 | 264 | |
| | | XD0-3684-CR | 36 | 84 | 29¼ | legal width b/b/f ped, 6"overhang | 4916 | 275 | |
| straight front full overhang specify Left or Right (seated) | | | | | | | | | |
| Double Pedestal Desk   | | | XD0-3066-AB | 30 | 66 | 29¼ | letter width b/b/f & f/f ped, 6"overhang | 5204 | 267 |
| | | XD0-3072-CD | 30 | 72 | 29¼ | legal width b/b/f & f/f ped, 6"overhang | 5341 | 277 | |
| | | XD0-3078-CD | 30 | 78 | 29¼ | legal width b/b/f & f/f ped, 6"overhang | 5469 | 287 | |
| | | XD0-3084-CD | 30 | 84 | 29¼ | legal width b/b/f & f/f ped, 6"overhang | 5602 | 297 | |
| | | XD0-3666-AB | 36 | 66 | 29¼ | letter width b/b/f & f/f ped, 6"overhang | 5472 | 281 | |
| | | XD0-3672-CD | 36 | 72 | 29¼ | legal width b/b/f & f/f ped, 6"overhang | 5607 | 292 | |
| | | XD0-3678-CD | 36 | 78 | 29¼ | legal width b/b/f & f/f ped, 6"overhang | 5747 | 303 | |
| | | XD0-3684-CD | 36 | 84 | 29¼ | legal width b/b/f & f/f ped, 6"overhang | 5885 | 314 | |
| | straight front full overhang | | | | | | | | |

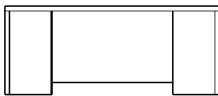
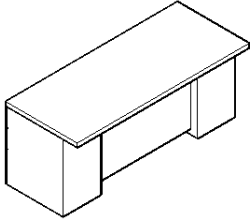
| Description | Model Number | Depth | Width | Height | Notes | Price (US\$) | Weight (lbs.) |
|--|--------------|-------|-------|--------|-------|--------------|---------------|
| Single Pedestal Desk Shell w/ No Pedestals   | XD000S-3066 | 30 | 66 | 29¼ | | 3556 | 189 |
| | XD000S-3072 | 30 | 72 | 29¼ | | 3689 | 199 |
| | XD000S-3078 | 30 | 78 | 29¼ | | 3821 | 208 |
| | XD000S-3084 | 30 | 84 | 29¼ | | 3954 | 218 |
| | XD000S-3666 | 36 | 66 | 29¼ | | 3775 | 214 |
| | XD000S-3672 | 36 | 72 | 29¼ | | 3910 | 225 |
| | XD000S-3678 | 36 | 78 | 29¼ | | 4050 | 236 |
| | XD000S-3684 | 36 | 84 | 29¼ | | | 4188 |

247

recessed center modesty panel
full overhang

Single Pedestal Desk

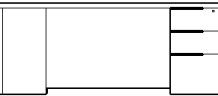
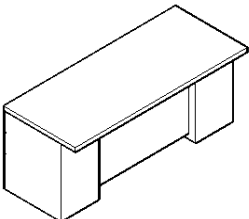
| | | | | | | | |
|---|----------------|----|----|-----|------------------------------------|------|-----|
|   | XD000S-3066-AR | 30 | 66 | 29¼ | letter width b/b/f ped, 6"overhang | 4530 | 228 |
| | XD000S-3072-CR | 30 | 72 | 29¼ | legal width b/b/f ped, 6"overhang | 4663 | 238 |
| | XD000S-3078-CR | 30 | 78 | 29¼ | legal width b/b/f ped, 6"overhang | 4791 | 248 |
| | XD000S-3084-CR | 30 | 84 | 29¼ | legal width b/b/f ped, 6"overhang | 4928 | 257 |
| | XD000S-3666-AR | 36 | 66 | 29¼ | letter width b/b/f ped, 6"overhang | 4772 | 248 |
| | XD000S-3672-CR | 36 | 72 | 29¼ | legal width b/b/f ped, 6"overhang | 4907 | 259 |
| | XD000S-3678-CR | 36 | 78 | 29¼ | legal width b/b/f ped, 6"overhang | 5047 | 270 |
| | XD000S-3684-CR | 36 | 84 | 29¼ | legal width b/b/f ped, 6"overhang | 5185 | 281 |

recessed center modesty panel
full overhang
specify Left or Right (seated)

Double Pedestal Desk

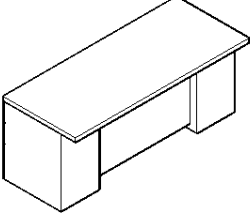
| | | | | | | | |
|---|----------------|----|----|-----|--|------|-----|
|   | XD000S-3066-AB | 30 | 66 | 29¼ | letter width b/b/f & f/f ped, 6"overhang | 5499 | 267 |
| | XD000S-3072-CD | 30 | 72 | 29¼ | legal width b/b/f & f/f ped, 6"overhang | 5632 | 277 |
| | XD000S-3078-CD | 30 | 78 | 29¼ | legal width b/b/f & f/f ped, 6"overhang | 5761 | 287 |
| | XD000S-3084-CD | 30 | 84 | 29¼ | legal width b/b/f & f/f ped, 6"overhang | 5897 | 297 |
| | XD000S-3666-AB | 36 | 66 | 29¼ | letter width b/b/f & f/f ped, 6"overhang | 5768 | 281 |
| | XD000S-3672-CD | 36 | 72 | 29¼ | legal width b/b/f & f/f ped, 6"overhang | 5903 | 292 |
| | XD000S-3678-CD | 36 | 78 | 29¼ | legal width b/b/f & f/f ped, 6"overhang | 6043 | 303 |
| | XD000S-3684-CD | 36 | 84 | 29¼ | legal width b/b/f & f/f ped, 6"overhang | 6181 | 314 |

recessed center modesty panel
full overhang

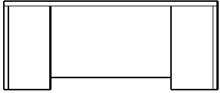
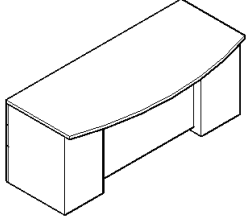
| Description | | Model Number | Depth | Width | Height | Notes | Price (US\$) | Weight (lbs.) |
|---|--|--------------|-------|-------|--------|-------|--------------|---------------|
|   | | XDB00S-3666 | 30/36 | 66 | 29¼ | | 4163 | 203 |
| | | XDB00S-3672 | 30/36 | 72 | 29¼ | | 4322 | 214 |
| | | XDB00S-3678 | 30/36 | 78 | 29¼ | | 4479 | 225 |
| | | XDB00S-3684 | 30/36 | 84 | 29¼ | | 4638 | 236 |
| | | XDB00S-4266 | 36/42 | 66 | 29¼ | | 4398 | 228 |
| | | XDB00S-4272 | 36/42 | 72 | 29¼ | | 4562 | 240 |
| | | XDB00S-4278 | 36/42 | 78 | 29¼ | | 4728 | 253 |
| | | XDB00S-4284 | 36/42 | 84 | 29¼ | | 4892 | 265 |

recessed center modesty panel

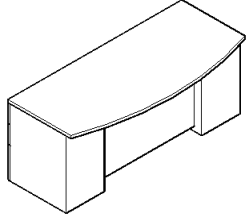
| Description | | Model Number | Depth | Width | Height | Notes | Price (US\$) | Weight (lbs.) |
|---|--|----------------|-------|-------|--------|------------------------|--------------|---------------|
|   | | XDB00S-3666-AR | 30/36 | 66 | 29¼ | letter width b/b/f ped | 5133 | 242 |
| | | XDB00S-3672-AR | 30/36 | 72 | 29¼ | letter width b/b/f ped | 5292 | 253 |
| | | XDB00S-3678-AR | 30/36 | 78 | 29¼ | letter width b/b/f ped | 5450 | 264 |
| | | XDB00S-3684-AR | 30/36 | 84 | 29¼ | letter width b/b/f ped | 5609 | 275 |
| | | XDB00S-4266-AR | 36/42 | 66 | 29¼ | letter width b/b/f ped | 5395 | 261 |
| | | XDB00S-4272-AR | 36/42 | 72 | 29¼ | letter width b/b/f ped | 5559 | 274 |
| | | XDB00S-4278-AR | 36/42 | 78 | 29¼ | letter width b/b/f ped | 5724 | 286 |
| | | XDB00S-4284-AR | 36/42 | 84 | 29¼ | letter width b/b/f ped | 5888 | 298 |

recessed center modesty panel
specify Left or Right (seated)

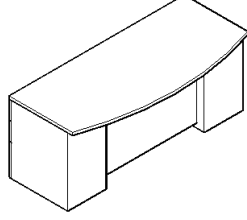
| Description | | Model Number | Depth | Width | Height | Notes | Price (US\$) | Weight (lbs.) |
|---|--|----------------|-------|-------|--------|------------------------------|--------------|---------------|
|   | | XDB00S-3666-AB | 30/36 | 66 | 29¼ | letter width b/b/f & f/f ped | 6103 | 281 |
| | | XDB00S-3672-CD | 30/36 | 72 | 29¼ | legal width b/b/f & f/f ped | 6315 | 296 |
| | | XDB00S-3678-CD | 30/36 | 78 | 29¼ | legal width b/b/f & f/f ped | 6419 | 303 |
| | | XDB00S-3684-CD | 30/36 | 84 | 29¼ | legal width b/b/f & f/f ped | 6582 | 314 |
| | | XDB00S-4266-AB | 36/42 | 66 | 29¼ | letter width b/b/f & f/f ped | 6391 | 295 |
| | | XDB00S-4272-CD | 36/42 | 72 | 29¼ | legal width b/b/f & f/f ped | 6555 | 307 |
| | | XDB00S-4278-CD | 36/42 | 78 | 29¼ | legal width b/b/f & f/f ped | 6720 | 319 |
| | | XDB00S-4284-CD | 36/42 | 84 | 29¼ | legal width b/b/f & f/f ped | 6884 | 332 |

recessed center modesty panel

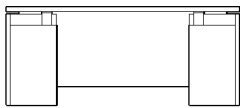
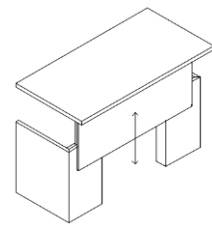
| Description | | Model Number | Depth | Width | Height | Notes | Price (US\$) | Weight (lbs.) |
|---|-------------|--------------|-------|-------|--------|-------|--------------|---------------|
| Desk Shell w/ Sit-To-Stand & No Pedestals   | XDOSSL-3066 | 30 | 66 | 29¼ | | 5121 | 229 | |
| | XDOSSL-3072 | 30 | 72 | 29¼ | | 5256 | 239 | |
| | XDOSSL-3078 | 30 | 78 | 29¼ | | 5339 | 248 | |
| | XDOSSL-3084 | 30 | 84 | 29¼ | | 5523 | 258 | |
| | XDOSSL-3666 | 36 | 66 | 29¼ | | 5339 | 254 | |
| | XDOSSL-3672 | 36 | 72 | 29¼ | | 5476 | 265 | |
| | XDOSSL-3678 | 36 | 78 | 29¼ | | 5614 | 276 | |
| | XDOSSL-3684 | 36 | 84 | 29¼ | | 5755 | 287 | |

adj. ht. worksurface & full modesty panel

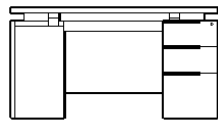
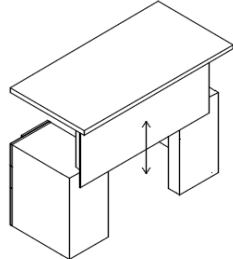
| | | | | | | | |
|--|----------------|----|----|-----|------------------------|------|-----|
| Single Pedestal Desk w/ Sit-To-Stand   | XDOSSL-3066-AR | 30 | 66 | 29¼ | letter width b/b/f ped | 6069 | 274 |
| | XDOSSL-3072-CR | 30 | 72 | 29¼ | legal width b/b/f ped | 6203 | 284 |
| | XDOSSL-3078-CR | 30 | 78 | 29¼ | legal width b/b/f ped | 6333 | 293 |
| | XDOSSL-3084-CR | 30 | 84 | 29¼ | legal width b/b/f ped | 6470 | 303 |
| | XDOSSL-3666-AR | 36 | 66 | 29¼ | letter width b/b/f ped | 6309 | 293 |
| | XDOSSL-3672-CR | 36 | 72 | 29¼ | legal width b/b/f ped | 6449 | 304 |
| | XDOSSL-3678-CR | 36 | 78 | 29¼ | legal width b/b/f ped | 6589 | 315 |
| | XDOSSL-3684-CR | 36 | 84 | 29¼ | legal width b/b/f ped | 6729 | 327 |

adj. ht. worksurface & modesty panel
straight front
specify Left or Right (seated)

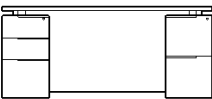
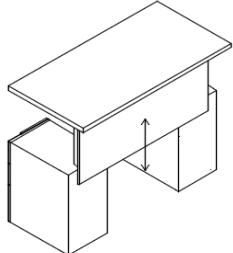
| | | | | | | | |
|--|----------------|----|----|-----|------------------------------|------|-----|
| Double Pedestal Desk w/ Sit-To-Stand   | XDOSSL-3066-AB | 30 | 66 | 29¼ | letter width b/b/f & f/f ped | 7016 | 319 |
| | XDOSSL-3072-CD | 30 | 72 | 29¼ | legal width b/b/f & f/f ped | 7147 | 329 |
| | XDOSSL-3078-CD | 30 | 78 | 29¼ | legal width b/b/f & f/f ped | 7281 | 338 |
| | XDOSSL-3084-CD | 30 | 84 | 29¼ | legal width b/b/f & f/f ped | 7417 | 348 |
| | XDOSSL-3666-AB | 36 | 66 | 29¼ | letter width b/b/f & f/f ped | 7279 | 332 |
| | XDOSSL-3672-CD | 36 | 72 | 29¼ | legal width b/b/f & f/f ped | 7419 | 344 |
| | XDOSSL-3678-CD | 36 | 78 | 29¼ | legal width b/b/f & f/f ped | 7558 | 355 |
| | XDOSSL-3684-CD | 36 | 84 | 29¼ | legal width b/b/f & f/f ped | 7699 | 366 |

adj. ht. worksurface & modesty panel
straight front

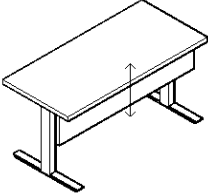
| Description | Model Number | Depth | Width | Height | Notes | Price (US\$) | Weight (lbs.) |
|---|--------------|-------|-------|--------|-------|--------------|---------------|
| Table Desk w/ Sit-To-Stand & No Pedestals   | XDTSSM-3066 | 30 | 66 | 29¼ | | 3773 | 139 |
| | XDTSSM-3072 | 30 | 72 | 29¼ | | 3888 | 147 |
| | XDTSSM-3078 | 30 | 78 | 29¼ | | 4005 | 155 |
| | XDTSSM-3084 | 30 | 84 | 29¼ | | 4125 | 163 |
| | XDTSSM-3666 | 36 | 66 | 29¼ | | 3908 | 152 |
| | XDTSSM-3672 | 36 | 72 | 29¼ | | 4028 | 162 |
| | XDTSSM-3678 | 36 | 78 | 29¼ | | 4154 | 171 |
| | XDTSSM-3684 | 36 | 84 | 29¼ | | 4278 | 180 |

adj. ht. worksurface & half modesty panel

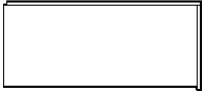
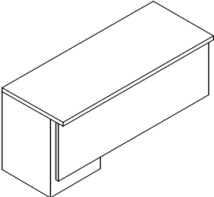
| | | | | | | | |
|--|------------|----|----|-----|--|------|-----|
| Runoff Desk w/ Panel End   | XDU-3066-R | 30 | 66 | 29¼ | | 2842 | 142 |
| | XDU-3072-R | 30 | 72 | 29¼ | | 2975 | 152 |
| | XDU-3078-R | 30 | 78 | 29¼ | | 3107 | 162 |
| | XDU-3084-R | 30 | 84 | 29¼ | | 3240 | 172 |
| | XDU-3666-R | 36 | 66 | 29¼ | | 3021 | 162 |
| | XDU-3672-R | 36 | 72 | 29¼ | | 3156 | 173 |
| | XDU-3678-R | 36 | 78 | 29¼ | | 3299 | 184 |
| | XDU-3684-R | 36 | 84 | 29¼ | | 3438 | 195 |

straight front full overhang
specify Left or Right (seated)

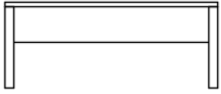
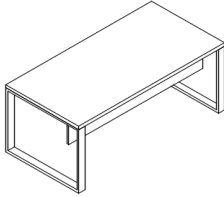
| Description | Model Number | Depth | Width | Height | Notes | Price (US\$) | Weight (lbs.) |
|--|--------------|-------|-------|--------|-------|--------------|---------------|
| Table Desk w/ Open Hoop Legs   | XDTH0M-3066 | 30 | 66 | 29¼ | | 3707 | 189 |
| | XDTH0M-3072 | 30 | 72 | 29¼ | | 3822 | 197 |
| | XDTH0M-3078 | 30 | 78 | 29¼ | | 3939 | 205 |
| | XDTH0M-3084 | 30 | 84 | 29¼ | | 4058 | 213 |
| | XDTH0M-3666 | 36 | 66 | 29¼ | | 3842 | 202 |
| | XDTH0M-3672 | 36 | 72 | 29¼ | | 3962 | 212 |
| | XDTH0M-3678 | 36 | 78 | 29¼ | | 4088 | 221 |
| | XDTH0M-3684 | 36 | 84 | 29¼ | | 4212 | 230 |

legs silver or black powdercoat

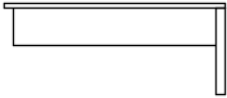
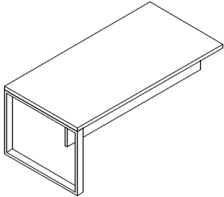
| | | | | | | | |
|--|-------------|----|----|-----|--|------|-----|
| Runoff Desk w/ Open Hoop Leg   | XDTUHM-3066 | 30 | 66 | 29¼ | | 2978 | 139 |
| | XDTUHM-3072 | 30 | 72 | 29¼ | | 3097 | 147 |
| | XDTUHM-3078 | 30 | 78 | 29¼ | | 3213 | 155 |
| | XDTUHM-3084 | 30 | 84 | 29¼ | | 3333 | 163 |
| | XDTUHM-3666 | 36 | 66 | 29¼ | | 3116 | 152 |
| | XDTUHM-3672 | 36 | 72 | 29¼ | | 3240 | 162 |
| | XDTUHM-3678 | 36 | 78 | 29¼ | | 3366 | 171 |
| | XDTUHM-3684 | 36 | 84 | 29¼ | | 3490 | 180 |

specify Left or Right (seated)
legs silver or black powdercoat

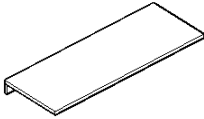
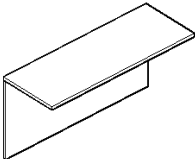
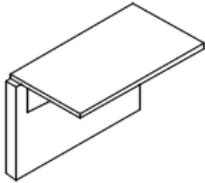
| Description | | Model Number | Depth | Width | Height | Notes | Price (US\$) | Weight (lbs.) | | |
|--|---|------------------------------|---|-------------|--------|-------|--------------|---------------|------|----|
| Bridge |  | XB000K-2030 | 20 | 30 | 29¼ | | 838 | 21 | | |
| | | XB000K-2036 | 20 | 36 | 29¼ | | 914 | 25 | | |
| | | XB000K-2042 | 20 | 42 | 29¼ | | 990 | 29 | | |
| | | XB000K-2048 | 20 | 48 | 29¼ | | 1063 | 33 | | |
| | | XB000K-2054 | 20 | 54 | 29¼ | | 1144 | 38 | | |
| | | XB000K-2060 | 20 | 60 | 29¼ | | 1219 | 42 | | |
| | | XB000K-2430 | 24 | 30 | 29¼ | | 898 | 25 | | |
| | | XB000K-2436 | 24 | 36 | 29¼ | | 974 | 30 | | |
| | | XB000K-2442 | 24 | 42 | 29¼ | | 1056 | 35 | | |
| | | XB000K-2448 | 24 | 48 | 29¼ | | 1135 | 40 | | |
| | | XB000K-2454 | 24 | 54 | 29¼ | | 1216 | 45 | | |
| | | XB000K-2460 | 24 | 60 | 29¼ | | 1295 | 50 | | |
| | | open back w/ solid wood keel | | | | | | | | |
| | | Bridge |  | XB000L-2030 | 20 | 30 | 29¼ | | 1292 | 50 |
| | | | | XB000L-2036 | 20 | 36 | 29¼ | | 1424 | 60 |
| | | | | XB000L-2042 | 20 | 42 | 29¼ | | 1554 | 70 |
| XB000L-2048 | 20 | | | 48 | 29¼ | | 1682 | 80 | | |
| XB000L-2054 | 20 | | | 54 | 29¼ | | 1815 | 90 | | |
| XB000L-2060 | 20 | | | 60 | 29¼ | | 1944 | 100 | | |
| XB000L-2430 | 24 | | | 30 | 29¼ | | 1362 | 54 | | |
| XB000L-2436 | 24 | | | 36 | 29¼ | | 1498 | 65 | | |
| XB000L-2442 | 24 | | | 42 | 29¼ | | 1630 | 76 | | |
| XB000L-2448 | 24 | | | 48 | 29¼ | | 1766 | 87 | | |
| XB000L-2454 | 24 | | | 54 | 29¼ | | 1901 | 98 | | |
| XB000L-2460 | 24 | | | 60 | 29¼ | | 2038 | 108 | | |
| full finished modesty panel | | | | | | | | | | |
| Bridge |  | | | XB000H-2430 | 24 | 30 | 29¼ | | 1453 | 43 |
| | | | | XB000H-2436 | 24 | 36 | 29¼ | | 1580 | 52 |
| | | | | XB000H-2442 | 24 | 42 | 29¼ | | 1702 | 60 |
| | | XB000H-2448 | 24 | 48 | 29¼ | | 1828 | 69 | | |
| | | XB000H-2454 | 24 | 54 | 29¼ | | 1957 | 78 | | |
| | | XB000H-2460 | 24 | 60 | 29¼ | | 2083 | 86 | | |
| hinged access modesty panel unfinished back | | | | | | | | | | |

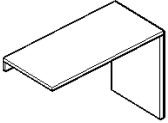
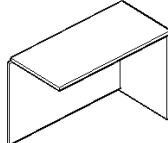
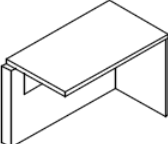
| Description | | Model Number | Depth | Width | Height | Notes | Price (US\$) | Weight (lbs.) | | |
|---|---|---|---|---------------|--------|-------|--------------|---------------|------|----|
| Return |  | XR000K-2030-R | 20 | 30 | 29¼ | | 1367 | 52 | | |
| | | XR000K-2036-R | 20 | 36 | 29¼ | | 1443 | 56 | | |
| | | XR000K-2042-R | 20 | 42 | 29¼ | | 1519 | 60 | | |
| | | XR000K-2048-R | 20 | 48 | 29¼ | | 1591 | 64 | | |
| | | XR000K-2054-R | 20 | 54 | 29¼ | | 1669 | 69 | | |
| | | XR000K-2060-R | 20 | 60 | 29¼ | | 1748 | 73 | | |
| | | XR000K-2430-R | 24 | 30 | 29¼ | | 1449 | 60 | | |
| | | XR000K-2436-R | 24 | 36 | 29¼ | | 1525 | 65 | | |
| | | XR000K-2442-R | 24 | 42 | 29¼ | | 1608 | 70 | | |
| | | XR000K-2448-R | 24 | 48 | 29¼ | | 1687 | 75 | | |
| | | XR000K-2454-R | 24 | 54 | 29¼ | | 1768 | 80 | | |
| | | XR000K-2460-R | 24 | 60 | 29¼ | | 1847 | 85 | | |
| | | open back w/ solid wood keel specify Left or Right | | | | | | | | |
| | | Return |  | XR000L-2030-R | 20 | 30 | 29¼ | | 1761 | 69 |
| XR000L-2036-R | 20 | | | 36 | 29¼ | | 1883 | 77 | | |
| XR000L-2042-R | 20 | | | 42 | 29¼ | | 2003 | 85 | | |
| XR000L-2048-R | 20 | | | 48 | 29¼ | | 2125 | 92 | | |
| XR000L-2054-R | 20 | | | 54 | 29¼ | | 2244 | 100 | | |
| XR000L-2060-R | 20 | | | 60 | 29¼ | | 2363 | 108 | | |
| XR000L-2430-R | 24 | | | 30 | 29¼ | | 1857 | 78 | | |
| XR000L-2436-R | 24 | | | 36 | 29¼ | | 1984 | 86 | | |
| XR000L-2442-R | 24 | | | 42 | 29¼ | | 2106 | 95 | | |
| XR000L-2448-R | 24 | | | 48 | 29¼ | | 2232 | 103 | | |
| XR000L-2454-R | 24 | | | 54 | 29¼ | | 2357 | 112 | | |
| XR000L-2460-R | 24 | | | 60 | 29¼ | | 2483 | 120 | | |
| full finished modesty panel specify Left or Right | | | | | | | | | | |
| Return |  | | | XR000H-2430-R | 24 | 30 | 29¼ | | 2005 | 78 |
| | | XR000H-2436-R | 24 | 36 | 29¼ | | 2132 | 87 | | |
| | | XR000H-2442-R | 24 | 42 | 29¼ | | 2254 | 95 | | |
| | | XR000H-2448-R | 24 | 48 | 29¼ | | 2383 | 104 | | |
| | | XR000H-2454-R | 24 | 54 | 29¼ | | 2508 | 113 | | |
| | | XR000H-2460-R | 24 | 60 | 29¼ | | 2635 | 121 | | |
| hinged access modesty panel unfinished back specify Left or Right | | | | | | | | | | |

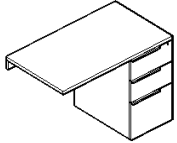
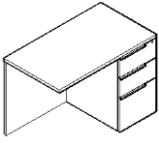
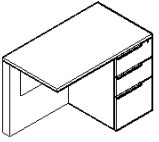
| Description | | Model Number | Depth | Width | Height | Notes | Price (US\$) | Weight (lbs.) | |
|--|---|---|---|----------------|--------|-------|--------------|---------------|------|
| Return |  | XR000K-2030-CR | 20 | 30 | 29¼ | | 2270 | 101 | |
| | | XR000K-2036-CR | 20 | 36 | 29¼ | | 2347 | 105 | |
| | | XR000K-2042-CR | 20 | 42 | 29¼ | | 2422 | 109 | |
| | | XR000K-2048-CR | 20 | 48 | 29¼ | | 2495 | 113 | |
| | | XR000K-2054-CR | 20 | 54 | 29¼ | | 2576 | 118 | |
| | | XR000K-2060-CR | 20 | 60 | 29¼ | | 2652 | 122 | |
| | | XR000K-2430-CR | 24 | 30 | 29¼ | | 2396 | 105 | |
| | | XR000K-2436-CR | 24 | 36 | 29¼ | | 2473 | 110 | |
| | | XR000K-2442-CR | 24 | 42 | 29¼ | | 2555 | 115 | |
| | | XR000K-2448-CR | 24 | 48 | 29¼ | | 2634 | 120 | |
| | | XR000K-2454-CR | 24 | 54 | 29¼ | | 2715 | 125 | |
| | | XR000K-2460-CR | 24 | 60 | 29¼ | | 2794 | 130 | |
| | | open back w/ solid wood keel legal width b/b/f pedestal specify Left or Right | | | | | | | |
| | | Return |  | XR000L-2030-CR | 20 | 30 | 29¼ | | 2668 |
| XR000L-2036-CR | 20 | | | 36 | 29¼ | | 2787 | 126 | |
| XR000L-2042-CR | 20 | | | 42 | 29¼ | | 2907 | 134 | |
| XR000L-2048-CR | 20 | | | 48 | 29¼ | | 3028 | 141 | |
| XR000L-2054-CR | 20 | | | 54 | 29¼ | | 3148 | 149 | |
| XR000L-2060-CR | 20 | | | 60 | 29¼ | | 3267 | 157 | |
| XR000L-2430-CR | 24 | | | 30 | 29¼ | | 2804 | 123 | |
| XR000L-2436-CR | 24 | | | 36 | 29¼ | | 2931 | 131 | |
| XR000L-2442-CR | 24 | | | 42 | 29¼ | | 3053 | 140 | |
| XR000L-2448-CR | 24 | | | 48 | 29¼ | | 3179 | 148 | |
| XR000L-2454-CR | 24 | | | 54 | 29¼ | | 3304 | 157 | |
| XR000L-2460-CR | 24 | | | 60 | 29¼ | | 3427 | 165 | |
| full finished modesty panel legal width b/b/f pedestal specify Left or Right | | | | | | | | | |
| Return |  | | | XR000H-2430-CR | 24 | 30 | 29¼ | | 2873 |
| | | XR000H-2436-CR | 24 | 36 | 29¼ | | 2999 | 123 | |
| | | XR000H-2442-CR | 24 | 42 | 29¼ | | 3124 | 131 | |
| | | XR000H-2448-CR | 24 | 48 | 29¼ | | 3251 | 140 | |
| | | XR000H-2454-CR | 24 | 54 | 29¼ | | 3376 | 149 | |
| | | XR000H-2460-CR | 24 | 60 | 29¼ | | 3502 | 157 | |
| | | hinged access modesty panel legal width b/b/f pedestal unfinished back specify Left or Right | | | | | | | |

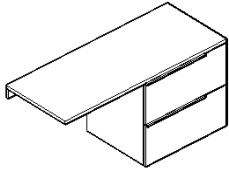
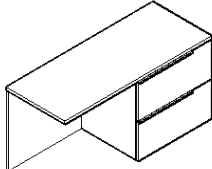
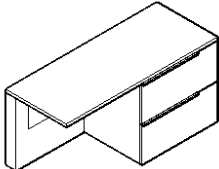
| Description | Model Number | Depth | Width | Height | Notes | Price (US\$) | Weight (lbs.) | |
|--|---|----------------|-------|--------|--------|--------------|---------------|-----|
| Return  open back w/ solid wood keel 30" w lateral file pedestal specify Left or Right | XR000K-2030-ER | 20 | 30 | 29 1/4 | | 2644 | 121 | |
| | XR000K-2036-ER | 20 | 36 | 29 1/4 | | 2717 | 125 | |
| | XR000K-2042-ER | 20 | 42 | 29 1/4 | | 2792 | 129 | |
| | XR000K-2048-ER | 20 | 48 | 29 1/4 | | 2869 | 133 | |
| | XR000K-2054-ER | 20 | 54 | 29 1/4 | | 2946 | 138 | |
| | XR000K-2060-ER | 20 | 60 | 29 1/4 | | 3022 | 142 | |
| | XR000K-2430-ER | 24 | 30 | 29 1/4 | | 2752 | 125 | |
| | XR000K-2436-ER | 24 | 36 | 29 1/4 | | 2829 | 130 | |
| | XR000K-2442-ER | 24 | 42 | 29 1/4 | | 2911 | 135 | |
| | XR000K-2448-ER | 24 | 48 | 29 1/4 | | 2990 | 140 | |
| | XR000K-2454-ER | 24 | 54 | 29 1/4 | | 3071 | 145 | |
| | XR000K-2460-ER | 24 | 60 | 29 1/4 | | 3154 | 150 | |
| | Return  full finished modesty panel 30" w lateral file pedestal specify Left or Right | XR000L-2030-ER | 20 | 30 | 29 1/4 | | 3038 | 138 |
| | | XR000L-2036-ER | 20 | 36 | 29 1/4 | | 3160 | 146 |
| XR000L-2042-ER | | 20 | 42 | 29 1/4 | | 3277 | 154 | |
| XR000L-2048-ER | | 20 | 48 | 29 1/4 | | 3399 | 161 | |
| XR000L-2054-ER | | 20 | 54 | 29 1/4 | | 3522 | 169 | |
| XR000L-2060-ER | | 20 | 60 | 29 1/4 | | 3640 | 177 | |
| XR000L-2430-ER | | 24 | 30 | 29 1/4 | | 3160 | 143 | |
| XR000L-2436-ER | | 24 | 36 | 29 1/4 | | 3287 | 151 | |
| XR000L-2442-ER | | 24 | 42 | 29 1/4 | | 3409 | 160 | |
| XR000L-2448-ER | | 24 | 48 | 29 1/4 | | 3535 | 168 | |
| XR000L-2454-ER | | 24 | 54 | 29 1/4 | | 3660 | 177 | |
| XR000L-2460-ER | | 24 | 60 | 29 1/4 | | 3787 | 185 | |
| Return  hinged access modesty panel 30" w lateral file pedestal unfinished back specify Left or Right | | XR000H-2448-ER | 24 | 48 | 29 1/4 | | 3531 | 151 |
| | | XR000H-2454-ER | 24 | 54 | 29 1/4 | | 3656 | 160 |
| | XR000H-2460-ER | 24 | 60 | 29 1/4 | | 3782 | 168 | |
| | | | | | | | | |

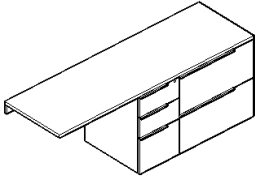
| Description | Model Number | Depth | Width | Height | Notes | Price (US\$) | Weight (lbs.) |
|--|-----------------|-------|-------|--------|-------|--------------|---------------|
| Return  | XR000K-2048-CER | 20 | 48 | 29¼ | | 4341 | 213 |
| | XR000K-2054-CER | 20 | 54 | 29¼ | | 4419 | 218 |
| | XR000K-2060-CER | 20 | 60 | 29¼ | | 4494 | 222 |
| | XR000K-2448-CER | 24 | 48 | 29¼ | | 4533 | 220 |
| | XR000K-2454-CER | 24 | 54 | 29¼ | | 4611 | 225 |
| | XR000K-2460-CER | 24 | 60 | 29¼ | | 4693 | 230 |

open back w/ solid wood keel
 legal width b/b/f ped + 30" w lateral file.
 specify Left or Right

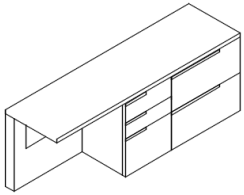
| | | | | | | | |
|--|-----------------|----|----|-----|--|------|-----|
| Return  | XR000L-2048-CER | 20 | 48 | 29¼ | | 4871 | 241 |
| | XR000L-2054-CER | 20 | 54 | 29¼ | | 4994 | 249 |
| | XR000L-2060-CER | 20 | 60 | 29¼ | | 5113 | 257 |
| | XR000L-2448-CER | 24 | 48 | 29¼ | | 5075 | 248 |
| | XR000L-2454-CER | 24 | 54 | 29¼ | | 5200 | 257 |
| | XR000L-2460-CER | 24 | 60 | 29¼ | | 5326 | 265 |

hinged access modesty panel
 legal width b/b/f ped +30" w lateral file.
 specify Left or Right

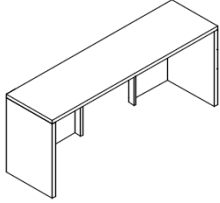
| Description | Model Number | Depth | Width | Height | Notes | Price (us\$) | Weight (lbs.) |
|--|--------------|-------|-------|--------|-------|--------------|---------------|
| Credenza Shell  | XC000K-2060 | 20 | 60 | 29¼ | | 2276 | 104 |
| | XC000K-2066 | 20 | 66 | 29¼ | | 2348 | 108 |
| | XC000K-2072 | 20 | 72 | 29¼ | | 2425 | 112 |
| | XC000K-2078 | 20 | 78 | 29¼ | | 2504 | 116 |
| | XC000K-2084 | 20 | 84 | 29¼ | | 2579 | 121 |
| | XC000K-2090 | 20 | 90 | 29¼ | | 2654 | 125 |
| | XC000K-2096 | 20 | 96 | 29¼ | | 2726 | 129 |
| | XC000K-2460 | 24 | 60 | 29¼ | | 2406 | 120 |
| | XC000K-2466 | 24 | 66 | 29¼ | | 2478 | 125 |
| | XC000K-2472 | 24 | 72 | 29¼ | | 2561 | 130 |
| | XC000K-2478 | 24 | 78 | 29¼ | | 2640 | 135 |
| | XC000K-2484 | 24 | 84 | 29¼ | | 2721 | 140 |
| | XC000K-2490 | 24 | 90 | 29¼ | | 2799 | 145 |
| | XC000K-2496 | 24 | 96 | 29¼ | | 2880 | 150 |

open back w/ solid wood keel

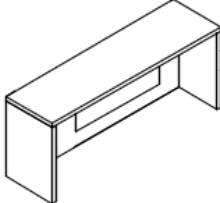
| | | | | | | | |
|---|-------------|----|----|-----|--|------|-----|
| Credenza Shell  | XC000H-2460 | 24 | 60 | 29¼ | | 3186 | 156 |
| | XC000H-2466 | 24 | 66 | 29¼ | | 3312 | 165 |
| | XC000H-2472 | 24 | 72 | 29¼ | | 3438 | 174 |
| | XC000H-2478 | 24 | 78 | 29¼ | | 3564 | 182 |
| | XC000H-2484 | 24 | 84 | 29¼ | | 3686 | 191 |
| | XC000H-2490 | 24 | 90 | 29¼ | | 3816 | 199 |
| | XC000H-2496 | 24 | 96 | 29¼ | | 3941 | 208 |

hinged access modesty panel

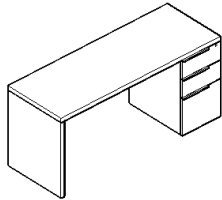
| Description | | Model Number | Depth | Width | Height | Notes | Price (us\$) | Weight (lbs.) |
|-----------------|---|----------------|-------|-------|--------|-------|--------------|---------------|
| Credenza |  | XC000K-2060-CR | 20 | 60 | 29 1/4 | | 3180 | 153 |
| | | XC000K-2066-CR | 20 | 66 | 29 1/4 | | 3252 | 157 |
| | | XC000K-2072-CR | 20 | 72 | 29 1/4 | | 3329 | 161 |
| | | XC000K-2078-CR | 20 | 78 | 29 1/4 | | 3408 | 165 |
| | | XC000K-2084-CR | 20 | 84 | 29 1/4 | | 3482 | 169 |
| | | XC000K-2090-CR | 20 | 90 | 29 1/4 | | 3558 | 174 |
| | | XC000K-2096-CR | 20 | 96 | 29 1/4 | | 3633 | 178 |
| | | XC000K-2460-CR | 24 | 60 | 29 1/4 | | 3346 | 165 |
| | | XC000K-2466-CR | 24 | 66 | 29 1/4 | | 3425 | 170 |
| | | XC000K-2472-CR | 24 | 72 | 29 1/4 | | 3505 | 175 |
| | | XC000K-2478-CR | 24 | 78 | 29 1/4 | | 3587 | 180 |
| | | XC000K-2484-CR | 24 | 84 | 29 1/4 | | 3668 | 185 |
| | | XC000K-2490-CR | 24 | 90 | 29 1/4 | | 3746 | 190 |
| | | XC000K-2496-CR | 24 | 96 | 29 1/4 | | 3827 | 195 |

open back w/ solid wood keel
 legal width b/b/f pedestal
 specify Left or Right (seated)

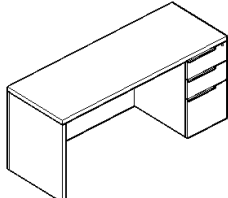
| | | | | | | | | |
|-----------------|--|----------------|----|----|--------|--|------|-----|
| Credenza |  | XC000H-2460-CR | 24 | 60 | 29 1/4 | | 4054 | 192 |
| | | XC000H-2466-CR | 24 | 66 | 29 1/4 | | 4179 | 201 |
| | | XC000H-2472-CR | 24 | 72 | 29 1/4 | | 4306 | 209 |
| | | XC000H-2478-CR | 24 | 78 | 29 1/4 | | 4432 | 218 |
| | | XC000H-2484-CR | 24 | 84 | 29 1/4 | | 4557 | 227 |
| | | XC000H-2490-CR | 24 | 90 | 29 1/4 | | 4684 | 235 |
| | | XC000H-2496-CR | 24 | 96 | 29 1/4 | | 4809 | 244 |

hinged access modesty panel
 legal width b/b/f pedestal
 specify Left or Right (seated)

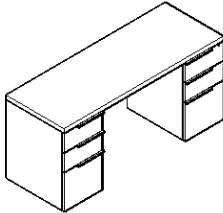
| Description | Model Number | Depth | Width | Height | Notes | Price (US\$) | Weight (lbs.) | |
|--|---|-------|-------|--------|---------------------------------|--------------|---------------|--|
| Credenza  | XC000K-2060-AKA | 20 | 60 | 29¼ | (2) letter width b/b/f pedestal | 4084 | 202 | |
| | XC000K-2066-AKA | 20 | 66 | 29¼ | (2) letter width b/b/f pedestal | 4155 | 206 | |
| | XC000K-2072-CKC | 20 | 72 | 29¼ | (2) legal width b/b/f pedestal | 4236 | 210 | |
| | XC000K-2078-CKC | 20 | 78 | 29¼ | (2) legal width b/b/f pedestal | 4312 | 214 | |
| | XC000K-2084-CKC | 20 | 84 | 29¼ | (2) legal width b/b/f pedestal | 4386 | 218 | |
| | XC000K-2090-CKC | 20 | 90 | 29¼ | (2) legal width b/b/f pedestal | 4465 | 223 | |
| | XC000K-2096-CKC | 20 | 96 | 29¼ | (2) legal width b/b/f pedestal | 4537 | 227 | |
| | XC000K-2460-AKA | 24 | 60 | 29¼ | (2) letter width b/b/f pedestal | 4293 | 210 | |
| | XC000K-2466-AKA | 24 | 66 | 29¼ | (2) letter width b/b/f pedestal | 4373 | 215 | |
| | XC000K-2472-CKC | 24 | 72 | 29¼ | (2) legal width b/b/f pedestal | 4452 | 220 | |
| | XC000K-2478-CKC | 24 | 78 | 29¼ | (2) legal width b/b/f pedestal | 4534 | 225 | |
| | XC000K-2484-CKC | 24 | 84 | 29¼ | (2) legal width b/b/f pedestal | 4612 | 230 | |
| | XC000K-2490-CKC | 24 | 90 | 29¼ | (2) legal width b/b/f pedestal | 4693 | 235 | |
| | XC000K-2496-CKC | 24 | 96 | 29¼ | (2) legal width b/b/f pedestal | 4771 | 240 | |
| | open back w/ solid wood keel two b/b/f pedestals | | | | | | | |

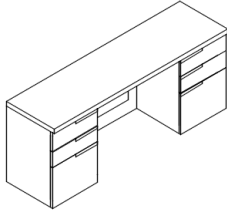
| | | | | | | | |
|--|--|----|----|-----|---------------------------------|------|-----|
| Credenza  | XC000H-2460-AKA | 24 | 60 | 29¼ | (2) letter width b/b/f pedestal | 4925 | 228 |
| | XC000H-2466-AKA | 24 | 66 | 29¼ | (2) letter width b/b/f pedestal | 5047 | 237 |
| | XC000H-2472-CKC | 24 | 72 | 29¼ | (2) legal width b/b/f pedestal | 5173 | 245 |
| | XC000H-2478-CKC | 24 | 78 | 29¼ | (2) legal width b/b/f pedestal | 5303 | 254 |
| | XC000H-2484-CKC | 24 | 84 | 29¼ | (2) legal width b/b/f pedestal | 5425 | 263 |
| | XC000H-2490-CKC | 24 | 90 | 29¼ | (2) legal width b/b/f pedestal | 5552 | 271 |
| | XC000H-2496-CKC | 24 | 96 | 29¼ | (2) legal width b/b/f pedestal | 5676 | 280 |
| | hinged access modesty panel two b/b/f pedestals | | | | | | |

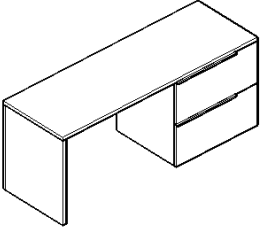
| Description | Model Number | Depth | Width | Height | Notes | Price (US\$) | Weight (lbs.) | |
|--|---|-------|-------|--------|-------|--------------|---------------|--|
| Credenza  | XC000K-2066-ER | 20 | 66 | 29¼ | | 3622 | 177 | |
| | XC000K-2072-ER | 20 | 72 | 29¼ | | 3702 | 181 | |
| | XC000K-2078-ER | 20 | 78 | 29¼ | | 3778 | 185 | |
| | XC000K-2084-ER | 20 | 84 | 29¼ | | 3853 | 189 | |
| | XC000K-2090-ER | 20 | 90 | 29¼ | | 3932 | 194 | |
| | XC000K-2096-ER | 20 | 96 | 29¼ | | 4003 | 198 | |
| | XC000K-2466-ER | 24 | 66 | 29¼ | | 3782 | 190 | |
| | XC000K-2472-ER | 24 | 72 | 29¼ | | 3864 | 195 | |
| | XC000K-2478-ER | 24 | 78 | 29¼ | | 3943 | 200 | |
| | XC000K-2484-ER | 24 | 84 | 29¼ | | 4024 | 205 | |
| | XC000K-2490-ER | 24 | 90 | 29¼ | | 4102 | 210 | |
| | XC000K-2496-ER | 24 | 96 | 29¼ | | 4183 | 215 | |
| | open back w/ solid wood keel 30" lateral file pedestal specify Left or Right (seated) | | | | | | | |

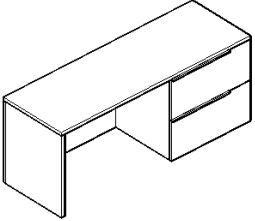
| | | | | | | | |
|---|--|----|----|-----|--|------|-----|
| Credenza  | XC000H-2460-ER | 24 | 60 | 29¼ | | 4334 | 203 |
| | XC000H-2466-ER | 24 | 66 | 29¼ | | 4459 | 212 |
| | XC000H-2472-ER | 24 | 72 | 29¼ | | 4586 | 220 |
| | XC000H-2478-ER | 24 | 78 | 29¼ | | 4712 | 229 |
| | XC000H-2484-ER | 24 | 84 | 29¼ | | 4834 | 238 |
| | XC000H-2490-ER | 24 | 90 | 29¼ | | 4964 | 246 |
| | XC000H-2496-ER | 24 | 96 | 29¼ | | 5089 | 255 |
| | hinged access modesty panel 30" lateral file pedestal specify Left or Right (seated) | | | | | | |

| Description | Model Number | Depth | Width | Height | Notes | Price (US\$) | Weight (lbs.) | |
|--|-----------------|-----------------|-------|--------|-------|--------------|---------------|-----|
| Credenza | XC000K-2090-EKE | 20 | 90 | 29¼ | | 5217 | 263 | |
| | XC000K-2096-EKE | 20 | 96 | 29¼ | | 5289 | 267 | |
| | XC000K-2490-EKE | 24 | 90 | 29¼ | | 5417 | 275 | |
| | XC000K-2496-EKE | 24 | 96 | 29¼ | | 5495 | 280 | |
| | | XC000H-2490-EKE | 24 | 90 | 29¼ | | 6120 | 293 |
| | | XC000H-2496-EKE | 24 | 96 | 29¼ | | 6245 | 302 |
| open back w/ solid wood keel two 30" lateral file pedestals | | XC000H-2490-EKE | 24 | 90 | 29¼ | | 6120 | 293 |
| hinged access modesty panel two 30" lateral file pedestals unfinished back | | XC000H-2496-EKE | 24 | 96 | 29¼ | | 6245 | 302 |

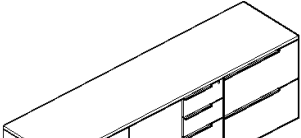
| Description | Model Number | Depth | Width | Height | Notes | Price (US\$) | Weight (lbs.) |
|--|-----------------|-------|-------|--------|-------|--------------|---------------|
| Credenza  | XC000K-2090-CER | 20 | 90 | 29¼ | | 5404 | 274 |
| | XC000K-2096-CER | 20 | 96 | 29¼ | | 5476 | 278 |
| | XC000K-2490-CER | 24 | 90 | 29¼ | | 5645 | 292 |
| | XC000K-2496-CER | 24 | 96 | 29¼ | | 5723 | 295 |

open back w/ solid wood keel
 legal width b/b/f pedestal + 30" lateral file pedestal
 specify Left or Right (seated)

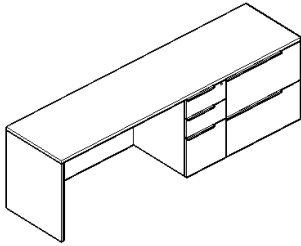
| | | | | | | | |
|--|-----------------|----|----|-----|--|------|-----|
| Credenza  | XC000H-2490-CER | 24 | 90 | 29¼ | | 6427 | 317 |
| | XC000H-2496-CER | 24 | 96 | 29¼ | | 6552 | 326 |

hinged access modesty panel
 legal width b/b/f pedestal + 30" lateral file pedestal
 unfinished back
 specify Left or Right (seated)

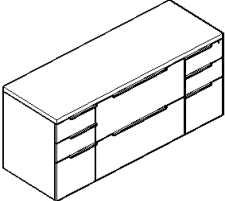
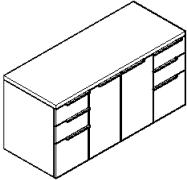
| Description | | Model Number | Depth | Width | Height | Notes | Price (US\$) | Weight (lbs.) |
|-------------------------------|---|------------------|-------|-------|--------|--|--------------|---------------|
| Freestanding Storage Credenza |  | XC000U-2060-AEA | 20 | 60 | 29¼ | two letter width b/b/f pedestals + one 30" w lateral file pedestal | 6545 | 337 |
| | | XC000U-2072-CFC | 20 | 72 | 29¼ | two legal width b/b/f pedestals + one 36" w lateral file pedestal | 6788 | 352 |
| | | XC000U-2460-AEA | 24 | 60 | 29¼ | two letter width b/b/f pedestals + one 30" w lateral file pedestal | 6825 | 345 |
| | | XC000U-2472-CFC | 24 | 72 | 29¼ | two legal width b/b/f pedestals + one 36" w lateral file pedestal | 7074 | 362 |
| Freestanding Storage Credenza |  | XC000U-2060-AHHA | 20 | 60 | 29¼ | two letter width b/b/f pedestals + one bay w/ hinged doors and 1 adj. shelf | 6198 | 297 |
| | | XC000U-2072-CHHC | 20 | 72 | 29¼ | two legal width b/b/f pedestals + one bay w/ hinged doors and 1 adj. shelf | 6441 | 312 |
| | | XC000U-2460-AHHA | 24 | 60 | 29¼ | two letter width b/b/f pedestals + one bay w/ hinged doors and 1 adj. shelf | 6493 | 305 |
| | | XC000U-2472-CHHC | 24 | 72 | 29¼ | two legal width b/b/f pedestals + one bay w/ hinged doors and 1 adj. shelf | 6741 | 322 |

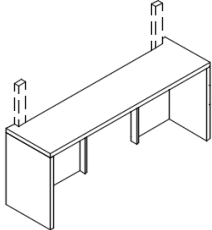
| Description | | Model Number | Depth | Width | Height | Notes | Price (US\$) | Weight (lbs.) |
|---------------------------------------|---|--------------|-------|-------|--------|-------|--------------|---------------|
| Stanchion Mount Credenza Shell |  | XC0A0K-2460 | 24 | 60 | 29 1/4 | | 2533 | 120 |
| | | XC0A0K-2466 | 24 | 66 | 29 1/4 | | 2609 | 125 |
| | | XC0A0K-2472 | 24 | 72 | 29 1/4 | | 2691 | 130 |
| | | XC0A0K-2478 | 24 | 78 | 29 1/4 | | 2771 | 135 |
| | | XC0A0K-2484 | 24 | 84 | 29 1/4 | | 2832 | 140 |
| | | XC0A0K-2490 | 24 | 90 | 29 1/4 | | 2929 | 145 |
| | | XC0A0K-2496 | 24 | 96 | 29 1/4 | | 3010 | 150 |

open back w/ solid wood keel

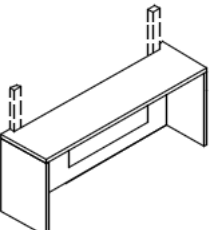
| | | | | | | | | |
|---------------------------------------|---|-------------|----|----|--------|--|------|-----|
| Stanchion Mount Credenza Shell |  | XC0A0H-2460 | 24 | 60 | 29 1/4 | | 3317 | 156 |
| | | XC0A0H-2466 | 24 | 66 | 29 1/4 | | 3442 | 165 |
| | | XC0A0H-2472 | 24 | 72 | 29 1/4 | | 3569 | 174 |
| | | XC0A0H-2478 | 24 | 78 | 29 1/4 | | 3695 | 182 |
| | | XC0A0H-2484 | 24 | 84 | 29 1/4 | | 3817 | 191 |
| | | XC0A0H-2490 | 24 | 90 | 29 1/4 | | 3947 | 199 |
| | | XC0A0H-2496 | 24 | 96 | 29 1/4 | | 4072 | 208 |

hinged access modesty panel
unfinished back

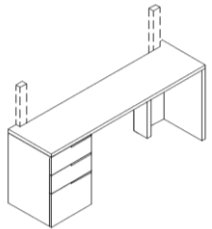
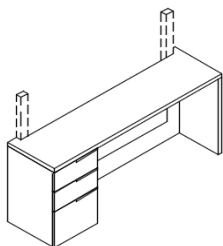
| Description | | Model Number | Depth | Width | Height | Notes | Price (US\$) | Weight (lbs.) |
|--|--|----------------|-------|-------|--------|-------|--------------|---------------|
| Stanchion Mount Credenza  <p>open back w/ solid wood keel supported with L shaped end panel legal width b/b/f pedestal specify Left or Right (seated)</p> | | XC0A0K-2460-CL | 24 | 60 | 29¼ | | 3477 | 165 |
| | | XC0A0K-2466-CL | 24 | 66 | 29¼ | | 3556 | 170 |
| | | XC0A0K-2472-CL | 24 | 72 | 29¼ | | 3635 | 175 |
| | | XC0A0K-2478-CL | 24 | 78 | 29¼ | | 3718 | 180 |
| | | XC0A0K-2484-CL | 24 | 84 | 29¼ | | 3799 | 185 |
| | | XC0A0K-2490-CL | 24 | 90 | 29¼ | | 3876 | 190 |
| | | XC0A0K-2496-CL | 24 | 96 | 29¼ | | 3957 | 195 |
| | | | | | | | | |
| Stanchion Mount Credenza  <p>hinged access modesty panel legal width b/b/f pedestal unfinished back specify Left or Right (seated)</p> | | XC0A0H-2460-CL | 24 | 60 | 29¼ | | 4185 | 192 |
| | | XC0A0H-2466-CL | 24 | 66 | 29¼ | | 4310 | 201 |
| | | XC0A0H-2472-CL | 24 | 72 | 29¼ | | 4436 | 209 |
| | | XC0A0H-2478-CL | 24 | 78 | 29¼ | | 4563 | 218 |
| | | XC0A0H-2484-CL | 24 | 84 | 29¼ | | 4688 | 227 |
| | | XC0A0H-2490-CL | 24 | 90 | 29¼ | | 4815 | 235 |
| | | XC0A0H-2496-CL | 24 | 96 | 29¼ | | 4939 | 244 |
| | | | | | | | | |

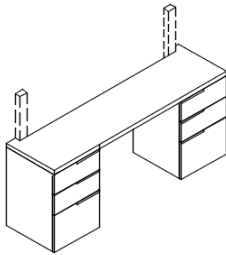
| Description | | Model Number | Depth | Width | Height | Notes | Price (US\$) | Weight (lbs.) |
|---------------------------------|---|-----------------|-------|-------|--------|---------------------------------|--------------|---------------|
| Stanchion Mount Credenza |  | XC0A0K-2460-AKA | 24 | 60 | 29¼ | (2) letter width b/b/f pedestal | 4424 | 210 |
| | | XC0A0K-2466-AKA | 24 | 66 | 29¼ | (2) letter width b/b/f pedestal | 4503 | 215 |
| | | XC0A0K-2472-CKC | 24 | 72 | 29¼ | (2) legal width b/b/f pedestal | 4582 | 220 |
| | | XC0A0K-2478-CKC | 24 | 78 | 29¼ | (2) legal width b/b/f pedestal | 4665 | 225 |
| | | XC0A0K-2484-CKC | 24 | 84 | 29¼ | (2) legal width b/b/f pedestal | 4743 | 230 |
| | | XC0A0K-2490-CKC | 24 | 90 | 29¼ | (2) legal width b/b/f pedestal | 4824 | 235 |
| | | XC0A0K-2496-CKC | 24 | 96 | 29¼ | (2) legal width b/b/f pedestal | 4901 | 240 |

open back w/ solid wood keel

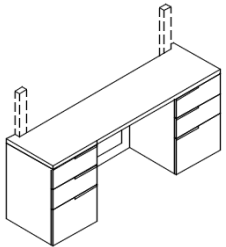
| | | | | | | | | |
|---------------------------------|---|-----------------|----|----|-----|---------------------------------|------|-----|
| Stanchion Mount Credenza |  | XC0A0H-2460-AKA | 24 | 60 | 29¼ | (2) letter width b/b/f pedestal | 5056 | 228 |
| | | XC0A0H-2466-AKA | 24 | 66 | 29¼ | (2) letter width b/b/f pedestal | 5178 | 237 |
| | | XC0A0H-2472-CKC | 24 | 72 | 29¼ | (2) legal width b/b/f pedestal | 5304 | 245 |
| | | XC0A0H-2478-CKC | 24 | 78 | 29¼ | (2) legal width b/b/f pedestal | 5434 | 254 |
| | | XC0A0H-2484-CKC | 24 | 84 | 29¼ | (2) legal width b/b/f pedestal | 5556 | 263 |
| | | XC0A0H-2490-CKC | 24 | 90 | 29¼ | (2) legal width b/b/f pedestal | 5682 | 271 |
| | | XC0A0H-2496-CKC | 24 | 96 | 29¼ | (2) legal width b/b/f pedestal | 5807 | 280 |

hinged access modesty panel

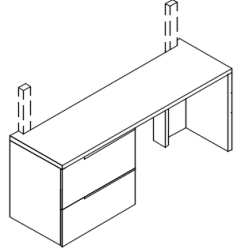
| Description | Model Number | Depth | Width | Height | Notes | Price (US\$) | Weight (lbs.) |
|--|----------------|-------|-------|--------|-------|--------------|---------------|
| Stanchion Mount Credenza  | XC0A0K-2460-EL | 24 | 60 | 29¼ | | 3836 | 185 |
| | XC0A0K-2466-EL | 24 | 66 | 29¼ | | 3912 | 190 |
| | XC0A0K-2472-EL | 24 | 72 | 29¼ | | 3995 | 195 |
| | XC0A0K-2478-EL | 24 | 78 | 29¼ | | 4074 | 200 |
| | XC0A0K-2484-EL | 24 | 84 | 29¼ | | 4155 | 205 |
| | XC0A0K-2490-EL | 24 | 90 | 29¼ | | 4232 | 210 |
| | XC0A0K-2496-EL | 24 | 96 | 29¼ | | 4313 | 215 |

open back w/ solid wood keel
 30" lateral file pedestal
 specify Left or Right (seated)

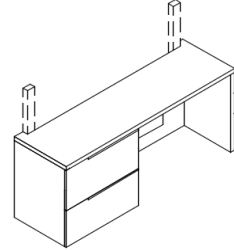
| | | | | | | | |
|--|----------------|----|----|-----|--|------|-----|
| Stanchion Mount Credenza  | XC0A0H-2460-EL | 24 | 60 | 29¼ | | 4465 | 203 |
| | XC0A0H-2466-EL | 24 | 66 | 29¼ | | 4590 | 212 |
| | XC0A0H-2472-EL | 24 | 72 | 29¼ | | 4716 | 220 |
| | XC0A0H-2478-EL | 24 | 78 | 29¼ | | 4843 | 229 |
| | XC0A0H-2484-EL | 24 | 84 | 29¼ | | 4965 | 238 |
| | XC0A0H-2490-EL | 24 | 90 | 29¼ | | 5094 | 246 |
| | XC0A0H-2496-EL | 24 | 96 | 29¼ | | 5219 | 255 |

hinged access modesty panel
 30" lateral file pedestal
 unfinished back
 specify Left or Right (seated)

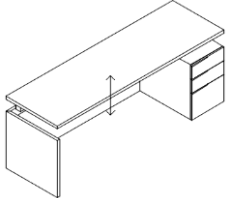
| Description | Model Number | Depth | Width | Height | Notes | Price (US\$) | Weight (lbs.) |
|---|----------------|-------|-------|--------|-----------------------|--------------|---------------|
| Sit-To-Stand Credenza  | XC0SSL-2460-CR | 24 | 60 | 29¼ | 23"x 58" worksurface | 5617 | 275 |
| | XC0SSL-2466-CR | 24 | 66 | 29¼ | 23"x 64" worksurface | 5752 | 286 |
| | XC0SSL-2472-CR | 24 | 72 | 29¼ | 23"x 70" worksurface, | 5889 | 298 |
| | XC0SSL-2478-CR | 24 | 78 | 29¼ | 23"x 76" worksurface | 6028 | 309 |
| | XC0SSL-2484-CR | 24 | 84 | 29¼ | 23"x 82" worksurface | 6163 | 320 |
| | XC0SSL-2490-CR | 24 | 90 | 29¼ | 23"x 88" worksurface | 6303 | 331 |
| | XC0SSL-2496-CR | 24 | 96 | 29¼ | 23"x 94" worksurface | 6438 | 342 |

sit-to-stand worksurface full modesty
 legal width b/b/f pedestal
 specify Left or Right (seated)

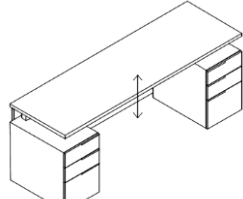
| | | | | | | | |
|---|-----------------|----|----|-----|---|------|-----|
| Sit-To-Stand Credenza  | XC0SSL-2460-AKA | 24 | 60 | 29¼ | 23"x 58" worksurface, (2) letter b/b/f peds | 6564 | 320 |
| | XC0SSL-2466-AKA | 24 | 66 | 29¼ | 23"x 64" worksurface, (2) letter b/b/f peds | 6696 | 331 |
| | XC0SSL-2472-CKC | 24 | 72 | 29¼ | 23"x 70" worksurface, (2) legal b/b/f peds | 6836 | 343 |
| | XC0SSL-2478-CKC | 24 | 78 | 29¼ | 23"x 76" worksurface, (2) legal b/b/f peds | 6975 | 354 |
| | XC0SSL-2484-CKC | 24 | 84 | 29¼ | 23"x 82" worksurface, (2) legal b/b/f peds | 7111 | 365 |
| | XC0SSL-2490-CKC | 24 | 90 | 29¼ | 23"x 88" worksurface, (2) legal b/b/f peds | 7247 | 376 |
| | XC0SSL-2496-CKC | 24 | 96 | 29¼ | 23"x 94" worksurface, (2) legal b/b/f peds | 7385 | 387 |

sit-to-stand worksurface
 two b/b/f pedestals & full modesty panel

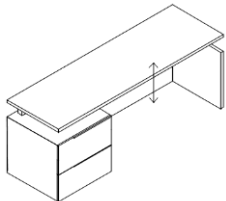
| | | | | | | | |
|---|----------------|----|----|-----|----------------------|------|-----|
| Sit-To-Stand Credenza  | XC0SSL-2460-EL | 24 | 60 | 29¼ | 23"x 58" worksurface | 5973 | 295 |
| | XC0SSL-2466-EL | 24 | 66 | 29¼ | 23"x 64" worksurface | 6108 | 306 |
| | XC0SSL-2472-EL | 24 | 72 | 29¼ | 23"x 70" worksurface | 6248 | 318 |
| | XC0SSL-2478-EL | 24 | 78 | 29¼ | 23"x 76" worksurface | 6384 | 329 |
| | XC0SSL-2484-EL | 24 | 84 | 29¼ | 23"x 82" worksurface | 6520 | 340 |
| | XC0SSL-2490-EL | 24 | 90 | 29¼ | 23"x 88" worksurface | 6659 | 351 |
| | XC0SSL-2496-EL | 24 | 96 | 29¼ | 23"x 96" worksurface | 6797 | 362 |

sit-to-stand worksurface
 30" lateral file pedestal & full modesty panel
 specify Left or Right (seated)

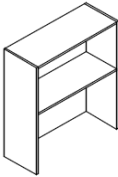
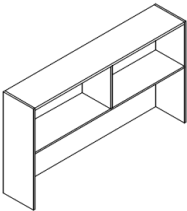
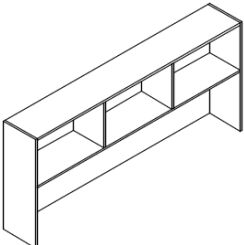
| Description | | Model Number | Depth | Width | Height | Notes | Price (US\$) | Weight (lbs.) |
|-------------------------------------|---|---------------------------------------|---|---------------|--------|---------------------------|--------------|---------------|
| Open Storage Hi-Rise One Bay |  | XSUN10-143641 | 14 1/4 | 36 | 41 1/4 | | 1943 | 76 |
| | | XSUN10-144241 | 14 1/4 | 42 | 41 1/4 | | 2012 | 84 |
| | | XSUN11-143653 | 14 1/4 | 36 | 53 1/4 | one adjust. shelf | 2278 | 102 |
| | | XSUN11-144253 | 14 1/4 | 42 | 53 1/4 | one adjust. shelf | 2371 | 114 |
| | | | | | | | | |
| Open Storage Hi-Rise Two Bay |  | XSUN20-144841 | 14 1/4 | 48 | 41 1/4 | | 2451 | 98 |
| | | XSUN20-145441 | 14 1/4 | 54 | 41 1/4 | | 2521 | 107 |
| | | XSUN20-146041 | 14 1/4 | 60 | 41 1/4 | | 2591 | 115 |
| | | XSUN20-146641 | 14 1/4 | 66 | 41 1/4 | | 2660 | 124 |
| | | XSUN20-147241 | 14 1/4 | 72 | 41 1/4 | | 2730 | 132 |
| | | XSUN20-147841 | 14 1/4 | 78 | 41 1/4 | | 2799 | 141 |
| | | XSUN21-144853 | 14 1/4 | 48 | 53 1/4 | one adjust. shelf ea. bay | 2985 | 134 |
| | | XSUN21-145453 | 14 1/4 | 54 | 53 1/4 | one adjust. shelf ea. bay | 3081 | 146 |
| | | XSUN21-146053 | 14 1/4 | 60 | 53 1/4 | one adjust. shelf ea. bay | 3173 | 158 |
| | | XSUN21-146653 | 14 1/4 | 66 | 53 1/4 | one adjust. shelf ea. bay | 3269 | 170 |
| | | XSUN21-147253 | 14 1/4 | 72 | 53 1/4 | one adjust. shelf ea. bay | 3362 | 182 |
| | | XSUN21-147853 | 14 1/4 | 78 | 53 1/4 | one adjust. shelf ea. bay | 3455 | 194 |
| | | Open Storage Hi-Rise Three Bay |  | XSUN30-148441 | 14 1/4 | 84 | 41 1/4 | |
| XSUN30-149041 | 14 1/4 | | | 90 | 41 1/4 | | 3305 | 163 |
| XSUN30-149641 | 14 1/4 | | | 96 | 41 1/4 | | 3374 | 172 |
| XSUN31-148453 | 14 1/4 | | | 84 | 53 1/4 | one adjust. shelf ea. bay | 4074 | 214 |
| XSUN31-149053 | 14 1/4 | | | 90 | 53 1/4 | one adjust. shelf ea. bay | 4166 | 226 |
| XSUN31-149653 | 14 1/4 | | | 96 | 53 1/4 | one adjust. shelf ea. bay | 4262 | 238 |
| | | | | | | | | |

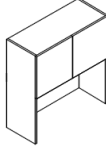
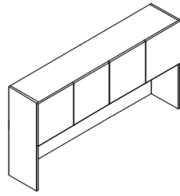
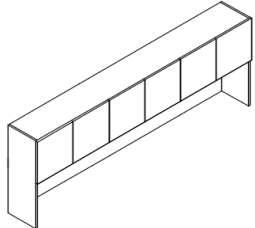
| Description | | Model Number | Depth | Width | Height | Notes | Price (US\$) | Weight (lbs.) | |
|--|---|--|---|---------------|--------|---------------------------|--------------|---------------|------|
| Hinged Door Hi-Rise Storage One Bay |  | XSUH10-153641 | 15 | 36 | 41¼ | | 2471 | 93 | |
| | | XSUH10-154241 | 15 | 42 | 41¼ | | 2564 | 104 | |
| | | XSUH11-153653 | 15 | 36 | 53¼ | one adjust. shelf | 2896 | 130 | |
| | | XSUH11-154253 | 15 | 42 | 53¼ | one adjust. shelf | 3025 | 146 | |
| | | <hr/> | | | | | | | |
| | | Hinged Door Hi-Rise Storage Two Bay |  | XSUH20-154841 | 15 | 48 | 41¼ | | 3410 |
| XSUH20-155441 | 15 | | | 54 | 41¼ | | 3502 | 132 | |
| XSUH20-156041 | 15 | | | 60 | 41¼ | | 3592 | 143 | |
| XSUH20-156641 | 15 | | | 66 | 41¼ | | 3684 | 155 | |
| XSUH20-157241 | 15 | | | 72 | 41¼ | | 3777 | 166 | |
| XSUH20-157841 | 15 | | | 78 | 41¼ | | 3870 | 177 | |
| XSUH21-154853 | 15 | | | 48 | 53¼ | one adjust. shelf ea. bay | 4062 | 171 | |
| XSUH21-155453 | 15 | | | 54 | 53¼ | one adjust. shelf ea. bay | 4194 | 187 | |
| XSUH21-156053 | 15 | | | 60 | 53¼ | one adjust. shelf ea. bay | 4323 | 203 | |
| XSUH21-156653 | 15 | | | 66 | 53¼ | one adjust. shelf ea. bay | 4453 | 220 | |
| XSUH21-157253 | 15 | | | 72 | 53¼ | one adjust. shelf ea. bay | 4585 | 236 | |
| XSUH21-157853 | 15 | | | 78 | 53¼ | one adjust. shelf ea. bay | 4714 | 252 | |
| <hr/> | | | | | | | | | |
| Hinged Door Hi-Rise Storage Three Bay |  | | | XSUH30-158441 | 15 | 84 | 41¼ | | 4712 |
| | | XSUH30-159041 | 15 | 90 | 41¼ | | 4805 | 205 | |
| | | XSUH30-159641 | 15 | 96 | 41¼ | | 4897 | 216 | |
| | | XSUH31-158453 | 15 | 84 | 53¼ | one adjust. shelf ea. bay | 5756 | 277 | |
| | | XSUH31-159053 | 15 | 90 | 53¼ | one adjust. shelf ea. bay | 5885 | 293 | |
| | | XSUH31-159653 | 15 | 96 | 53¼ | one adjust. shelf ea. bay | 6014 | 309 | |

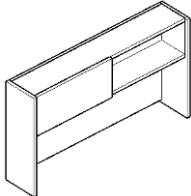
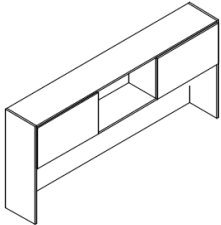
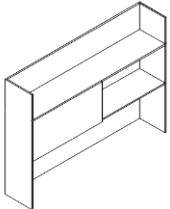
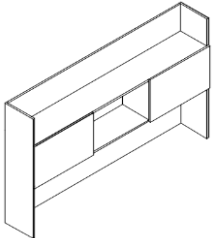
| Description | | Model Number | Depth | Width | Height | Notes | Price (US\$) | Weight (lbs.) |
|--|---|---------------|-------|-------|--------|-------|--------------|---------------|
| Sliding Door Hi-Rise Storage Two Bay |  | XSUK20-154841 | 15 | 48 | 41¼ | | 3646 | 142 |
| | | XSUK20-155441 | 15 | 54 | 41¼ | | 3722 | 152 |
| | | XSUK20-156041 | 15 | 60 | 41¼ | | 3798 | 162 |
| | | XSUK20-156641 | 15 | 66 | 41¼ | | 3871 | 172 |
| | | XSUK20-157241 | 15 | 72 | 41¼ | | 3947 | 182 |
| | | XSUK20-157841 | 15 | 78 | 41¼ | | 4023 | 192 |
| | | XSUK20-158441 | 15 | 84 | 41¼ | | 4099 | 201 |
| | | XSUK20-159041 | 15 | 90 | 41¼ | | 4172 | 211 |
| Sliding Door Hi-Rise Storage Three Bay |  | XSUK30-158441 | 15 | 84 | 41¼ | | 4793 | 206 |
| | | XSUK30-159041 | 15 | 90 | 41¼ | | 4872 | 217 |
| | | XSUK30-159641 | 15 | 96 | 41¼ | | 4952 | 227 |
| Sliding Door Hi-Rise Storage Open Shelf Above Two Bay |  | XSUK21-154853 | 15 | 48 | 53¼ | | 4215 | 180 |
| | | XSUK21-155453 | 15 | 54 | 53¼ | | 4308 | 192 |
| | | XSUK21-156053 | 15 | 60 | 53¼ | | 4401 | 204 |
| | | XSUK21-156653 | 15 | 66 | 53¼ | | 4494 | 217 |
| | | XSUK21-157253 | 15 | 72 | 53¼ | | 4586 | 229 |
| | | XSUK21-157853 | 15 | 78 | 53¼ | | 4679 | 241 |
| | | XSUK21-158453 | 15 | 84 | 53¼ | | 4772 | 254 |
| | | XSUK21-159053 | 15 | 90 | 53¼ | | 4864 | 266 |
| Sliding Door Hi-Rise Storage Open Shelf Above Three Bay |  | XSUK31-158453 | 15 | 84 | 53¼ | | 5468 | 259 |
| | | XSUK31-159053 | 15 | 90 | 53¼ | | 5564 | 272 |
| | | XSUK31-159653 | 15 | 96 | 53¼ | | 5660 | 284 |

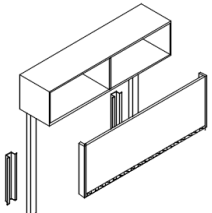
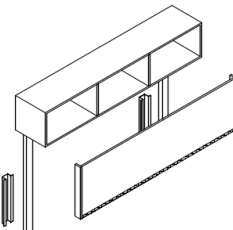
| Description | | Model Number | Depth | Width | Height | Notes | Price (US\$) | Weight (lbs.) | |
|--|--|---------------------|---------------------|-------|--------|---------------------------|--------------|---------------|-----|
| Stanchion Mounted Open Storage Two Bay  includes two stanchions, two hat channels, fabric covered tackboard with continuous wire mgmt. brush | | XSMN20-146041-0-TBF | 14¼ | 60 | 41¼ | | 4013 | 184 | |
| | | XSMN20-146641-0-TBF | 14¼ | 66 | 41¼ | | 4101 | 193 | |
| | | XSMN20-147241-0-TBF | 14¼ | 72 | 41¼ | | 4187 | 202 | |
| | | XSMN20-147841-0-TBF | 14¼ | 78 | 41¼ | | 4271 | 211 | |
| | | XSMN21-146053-0-TBF | 14¼ | 60 | 53¼ | one adjust. shelf ea. bay | 4600 | 227 | |
| | | XSMN21-146653-0-TBF | 14¼ | 66 | 53¼ | one adjust. shelf ea. bay | 4710 | 240 | |
| | | XSMN21-147253-0-TBF | 14¼ | 72 | 53¼ | one adjust. shelf ea. bay | 4819 | 252 | |
| | | XSMN21-147853-0-TBF | 14¼ | 78 | 53¼ | one adjust. shelf ea. bay | 4930 | 264 | |
| | Stanchion Mounted Open Storage Three Bay  includes two stanchions, two hat channels, fabric covered tackboard with continuous wire mgmt. brush | | XSMN30-148441-0-TBF | 14¼ | 84 | 41¼ | | 4729 | 225 |
| | | | XSMN30-149041-0-TBF | 14¼ | 90 | 41¼ | | 4813 | 234 |
| | | XSMN30-149641-0-TBF | 14¼ | 96 | 41¼ | | 4901 | 243 | |
| | | XSMN31-148453-0-TBF | 14¼ | 84 | 53¼ | one adjust. shelf ea. bay | 5564 | 285 | |
| | | XSMN31-149053-0-TBF | 14¼ | 90 | 53¼ | one adjust. shelf ea. bay | 5675 | 297 | |
| | | XSMN31-149653-0-TBF | 14¼ | 96 | 53¼ | one adjust. shelf ea. bay | 5786 | 309 | |

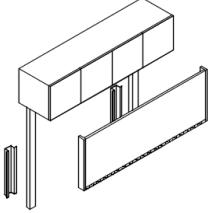
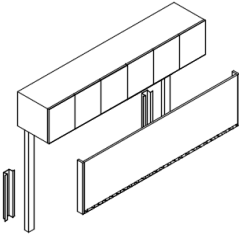
| Description | Model Number | Depth | Width | Height | Notes | Price (US\$) | Weight (lbs.) | |
|---|---|---------------------|-------|--------|---------------------------|--------------|---------------|-----|
| Stanchion Mounted Hinged Door Storage Two Bay  includes two stanchions, two hat channels, fabric covered tackboard with continuous wire mgmt. brush | XSMH20-156041-0-TBF | 15 | 60 | 41¼ | | 4988 | 209 | |
| | XSMH20-156641-0-TBF | 15 | 66 | 41¼ | | 5092 | 221 | |
| | XSMH20-157241-0-TBF | 15 | 72 | 41¼ | | 5201 | 232 | |
| | XSMH20-157841-0-TBF | 15 | 78 | 41¼ | | 5309 | 243 | |
| | XSMH21-156053-0-TBF | 15 | 60 | 53¼ | one adjust. shelf ea. bay | 5717 | 269 | |
| | XSMH21-156653-0-TBF | 15 | 66 | 53¼ | one adjust. shelf ea. bay | 5864 | 285 | |
| | XSMH21-157253-0-TBF | 15 | 72 | 53¼ | one adjust. shelf ea. bay | 6009 | 302 | |
| | XSMH21-157853-0-TBF | 15 | 78 | 53¼ | one adjust. shelf ea. bay | 6153 | 318 | |
| | Stanchion Mounted Hinged Door Storage Three Bay  includes two stanchions, two hat channels, fabric covered tackboard with continuous wire mgmt. brush | XSMH30-158441-0-TBF | 15 | 84 | 41¼ | | 6166 | 260 |
| | | XSMH30-159041-0-TBF | 15 | 90 | 41¼ | | 6273 | 271 |
| XSMH30-159641-0-TBF | | 15 | 96 | 41¼ | | 6378 | 283 | |
| XSMH31-158453-0-TBF | | 15 | 84 | 53¼ | one adjust. shelf ea. bay | 7206 | 343 | |
| XSMH31-159053-0-TBF | | 15 | 90 | 53¼ | one adjust. shelf ea. bay | 7350 | 359 | |
| XSMH31-159653-0-TBF | | 15 | 96 | 53¼ | one adjust. shelf ea. bay | 7498 | 376 | |

| Description | Model Number | Depth | Width | Height | Notes | Price (US\$) | Weight (lbs.) |
|---|---------------------|-------|-------|--------|-------|--------------|---------------|
| Stanchion Mounted Sliding Door Storage Two Bay | XSMK20-156041-0-TBF | 15 | 60 | 41¼ | | 4920 | 199 |
| | XSMK20-156641-0-TBF | 15 | 66 | 41¼ | | 5017 | 209 |
| | XSMK20-157241-0-TBF | 15 | 72 | 41¼ | | 5116 | 219 |
| | XSMK20-157841-0-TBF | 15 | 78 | 41¼ | | 5211 | 229 |

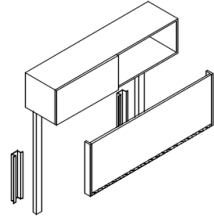

includes two stanchions, two hat channels, fabric covered tackboard with continuous wire mgmt. brush

| | | | | | | | |
|---|---------------------|----|----|-----|--|------|-----|
| Stanchion Mounted Sliding Door Storage Three Bay | XSMK30-158441-0-TBF | 15 | 84 | 41¼ | | 6051 | 250 |
| | XSMK30-159041-0-TBF | 15 | 90 | 41¼ | | 6152 | 261 |
| | XSMK30-159641-0-TBF | 15 | 96 | 41¼ | | 6253 | 271 |

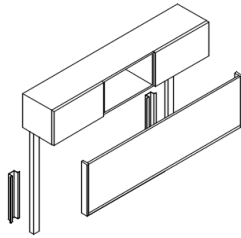

includes two stanchions, two hat channels, fabric covered tackboard with continuous wire mgmt. brush

| Description | Model Number | Depth | Width | Height | Notes | Price (US\$) | Weight (lbs.) |
|--|---------------------|-------|-------|--------|-------|--------------|---------------|
| Stanchion Mounted Sliding Door Storage Open Shelf Above - Two Bay | XSMK21-156053-0-TBF | 15 | 60 | 53¼ | | 5522 | 244 |
| | XSMK21-156653-0-TBF | 15 | 66 | 53¼ | | 5643 | 257 |
| | XSMK21-157253-0-TBF | 15 | 72 | 53¼ | | 5769 | 271 |
| | XSMK21-157853-0-TBF | 15 | 78 | 53¼ | | 5889 | 285 |
| | XSMK21-158453-0-TBF | 15 | 84 | 53¼ | | 6014 | 298 |
| | XSMK21-159053-0-TBF | 15 | 90 | 53¼ | | 6138 | 312 |

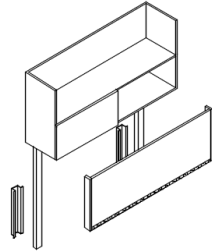

includes two stanchions, two hat channels,
fabric covered tackboard with continuous
wire mgmt. brush

| | | | | | | | |
|---|---------------------|----|----|-----|--|------|-----|
| Stanchion Mounted Sliding Door Storage w/ Open Shelf Above - Three Bay | XSMK31-158453-0-TBF | 15 | 84 | 53¼ | | 6786 | 312 |
| | XSMK31-159053-0-TBF | 15 | 90 | 53¼ | | 6914 | 326 |
| | XSMK31-159653-0-TBF | 15 | 96 | 53¼ | | 7038 | 340 |

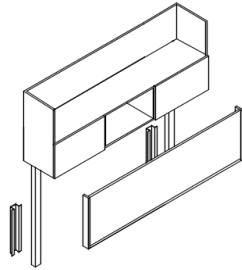

includes two stanchions, two hat channels,
fabric covered tackboard with continuous
wire mgmt. brush

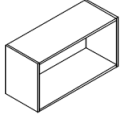
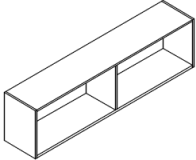
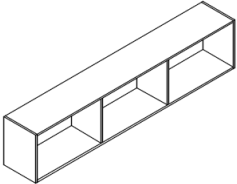
| Description | | Model Number | Depth | Width | Height | Notes | Price (US\$) | Weight (lbs.) |
|---|--|---------------|--------|-------|--------|---------------------------|--------------|---------------|
| Open Storage Wall Hung One Bay |  | XSWN10-143621 | 14 3/4 | 36 | 20 3/4 | | 1404 | 49 |
| | | XSWN10-144221 | 14 3/4 | 42 | 20 3/4 | | 1457 | 55 |
| | | XSWN11-143633 | 14 3/4 | 36 | 32 3/4 | one adjust. shelf | 1739 | 76 |
| | | XSWN11-144233 | 14 3/4 | 42 | 32 3/4 | one adjust. shelf | 1815 | 85 |
| Open Storage Wall Hung Two Bay |  | XSWN20-144821 | 14 3/4 | 48 | 20 3/4 | | 1886 | 67 |
| | | XSWN20-145421 | 14 3/4 | 54 | 20 3/4 | | 1939 | 74 |
| | | XSWN20-146021 | 14 3/4 | 60 | 20 3/4 | | 1992 | 80 |
| | | XSWN20-146621 | 14 3/4 | 66 | 20 3/4 | | 2042 | 86 |
| | | XSWN20-147221 | 14 3/4 | 72 | 20 3/4 | | 2095 | 92 |
| | | XSWN20-147821 | 14 3/4 | 78 | 20 3/4 | | 2145 | 98 |
| | | XSWN21-144833 | 14 3/4 | 48 | 32 3/4 | one adjust. shelf ea. bay | 2423 | 104 |
| | | XSWN21-145433 | 14 3/4 | 54 | 32 3/4 | one adjust. shelf ea. bay | 2499 | 113 |
| | | XSWN21-146033 | 14 3/4 | 60 | 32 3/4 | one adjust. shelf ea. bay | 2575 | 123 |
| | | XSWN21-146633 | 14 3/4 | 66 | 32 3/4 | one adjust. shelf ea. bay | 2651 | 132 |
| | | XSWN21-147233 | 14 3/4 | 72 | 32 3/4 | one adjust. shelf ea. bay | 2727 | 141 |
| | | XSWN21-147833 | 14 3/4 | 78 | 32 3/4 | one adjust. shelf ea. bay | 2804 | 151 |
| Open Storage Wall Hung Three Bay |  | XSWN30-148421 | 14 3/4 | 84 | 20 3/4 | | 2577 | 110 |
| | | XSWN30-149021 | 14 3/4 | 90 | 20 3/4 | | 2630 | 116 |
| | | XSWN30-149621 | 14 3/4 | 96 | 20 3/4 | | 2680 | 123 |
| | | XSWN31-148433 | 14 3/4 | 84 | 32 3/4 | one adjust. shelf ea. bay | 3416 | 170 |
| | | XSWN31-149033 | 14 3/4 | 90 | 32 3/4 | one adjust. shelf ea. bay | 3492 | 179 |
| | | XSWN31-149633 | 14 3/4 | 96 | 32 3/4 | one adjust. shelf ea. bay | 3568 | 189 |

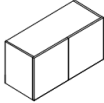
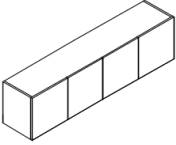
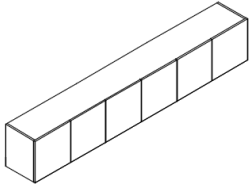
| Description | | Model Number | Depth | Width | Height | Notes | Price (US\$) | Weight (lbs.) |
|--|---|--|---|---------------|--------|---------------------------|--------------|---------------|
| Hinged Door Wall Hung Storage One Bay |  | XSWH10-153621 | 15 | 36 | 20 3/4 | | 1939 | 67 |
| | | XSWH10-154221 | 15 | 42 | 20 3/4 | | 2015 | 76 |
| | | XSWH11-153633 | 15 | 36 | 32 3/4 | one adjust. shelf | 2361 | 104 |
| | | XSWH11-154233 | 15 | 42 | 32 3/4 | one adjust. shelf | 2477 | 118 |
| | | | | | | | | |
| Hinged Door Wall Hung Storage Two Bay |  | XSWH20-154821 | 15 | 48 | 20 3/4 | | 2858 | 92 |
| | | XSWH20-155421 | 15 | 54 | 20 3/4 | | 2934 | 101 |
| | | XSWH20-156021 | 15 | 60 | 20 3/4 | | 3010 | 110 |
| | | XSWH20-156621 | 15 | 66 | 20 3/4 | | 3086 | 119 |
| | | XSWH20-157221 | 15 | 72 | 20 3/4 | | 3162 | 128 |
| | | XSWH20-157821 | 15 | 78 | 20 3/4 | | 3238 | 137 |
| | | XSWH21-154833 | 15 | 48 | 32 3/4 | one adjust. shelf ea. bay | 3510 | 142 |
| | | XSWH21-155433 | 15 | 54 | 32 3/4 | one adjust. shelf ea. bay | 3626 | 156 |
| | | XSWH21-156033 | 15 | 60 | 32 3/4 | one adjust. shelf ea. bay | 3738 | 170 |
| | | XSWH21-156633 | 15 | 66 | 32 3/4 | one adjust. shelf ea. bay | 3854 | 184 |
| | | XSWH21-157233 | 15 | 72 | 32 3/4 | one adjust. shelf ea. bay | 3970 | 197 |
| | | XSWH21-157835 | 15 | 78 | 32 3/4 | one adjust. shelf ea. bay | 4086 | 211 |
| | | Hinged Door Wall Hung Storage Three Bay |  | XSWH30-158421 | 15 | 84 | 20 3/4 | |
| XSWH30-159021 | 15 | | | 90 | 20 3/4 | | 4153 | 161 |
| XSWH30-159621 | 15 | | | 96 | 20 3/4 | | 4233 | 170 |
| XSWH31-158433 | 15 | | | 84 | 32 3/4 | one adjust. shelf ea. bay | 5118 | 236 |
| XSWH31-159033 | 15 | | | 90 | 32 3/4 | one adjust. shelf ea. bay | 5234 | 249 |
| XSWH31-159633 | 15 | | | 96 | 32 3/4 | one adjust. shelf ea. bay | 5350 | 263 |
| | | | | | | | | |

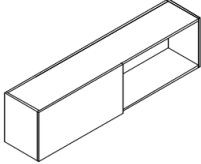
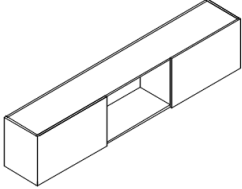
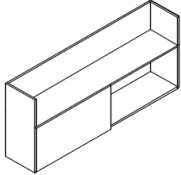
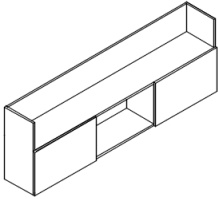
| Description | | Model Number | Depth | Width | Height | Notes | Price | Weight | (US\$) | (lbs.) |
|---|---|---------------|-------|-------|--------|-------|-------|--------|--------|--------|
| Sliding Door Wall Hung Storage Two Bay |  | XSWK20-154821 | 15 | 48 | 20 3/4 | | | | 2789 | 81 |
| | | XSWK20-155421 | 15 | 54 | 20 3/4 | | | | 2855 | 89 |
| | | XSWK20-156021 | 15 | 60 | 20 3/4 | | | | 2918 | 97 |
| | | XSWK20-156621 | 15 | 66 | 20 3/4 | | | | 2985 | 104 |
| | | XSWK20-157221 | 15 | 72 | 20 3/4 | | | | 3051 | 112 |
| | | XSWK20-157821 | 15 | 78 | 20 3/4 | | | | 3117 | 120 |
| | | XSWK20-158421 | 15 | 84 | 20 3/4 | | | | 3233 | 133 |
| | | XSWK20-159021 | 15 | 90 | 20 3/4 | | | | 3303 | 142 |
| Sliding Door Wall Hung Storage Three Bay |  | XSWK30-158421 | 15 | 84 | 20 3/4 | | | | 3943 | 140 |
| | | XSWK30-159021 | 15 | 90 | 20 3/4 | | | | 4012 | 148 |
| | | XSWK30-159621 | 15 | 96 | 20 3/4 | | | | 4082 | 156 |
| Sliding Door Wall Hung Storage w/ open shelf above Two Bay |  | XSWK21-154833 | 15 | 48 | 32 3/4 | | | | 3322 | 117 |
| | | XSWK21-155433 | 15 | 54 | 32 3/4 | | | | 3412 | 128 |
| | | XSWK21-156033 | 15 | 60 | 32 3/4 | | | | 3501 | 139 |
| | | XSWK21-156633 | 15 | 66 | 32 3/4 | | | | 3591 | 150 |
| | | XSWK21-157233 | 15 | 72 | 32 3/4 | | | | 3677 | 161 |
| | | XSWK21-157833 | 15 | 78 | 32 3/4 | | | | 3766 | 172 |
| | | XSWK21-158433 | 15 | 84 | 32 3/4 | | | | 3856 | 182 |
| | | XSWK21-159033 | 15 | 90 | 32 3/4 | | | | 3945 | 193 |
| Sliding Door Wall Hung Storage w/ open shelf above Three Bay |  | XSWK31-158433 | 15 | 84 | 32 3/4 | | | | 4641 | 198 |
| | | XSWK31-159033 | 15 | 90 | 32 3/4 | | | | 4731 | 209 |
| | | XSWK31-159633 | 15 | 96 | 32 3/4 | | | | 4824 | 220 |

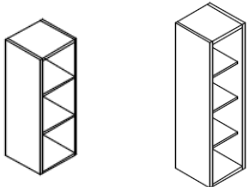
| Description | | Model Number | Depth | Width | Height | Notes | Price (US\$) | Weight (lbs.) | |
|--------------------------------------|---|---------------|------------------|------------------|------------------|----------------|--------------|---------------|--|
| Upper Storage w/ Open Shelves |  | XSUS12-141641 | 14 $\frac{1}{4}$ | 15 $\frac{3}{4}$ | 41 $\frac{1}{4}$ | 2 adj. shelves | 2022 | 56 | |
| | | XSUS12-141941 | 14 $\frac{1}{4}$ | 18 $\frac{3}{4}$ | 41 $\frac{1}{4}$ | 2 adj. shelves | 2068 | 62 | |
| | | XSUS13-141653 | 14 $\frac{1}{4}$ | 15 $\frac{3}{4}$ | 53 $\frac{1}{4}$ | 3 adj. shelves | 2274 | 72 | |
| | | XSUS13-141953 | 14 $\frac{1}{4}$ | 18 $\frac{3}{4}$ | 53 $\frac{1}{4}$ | 3 adj. shelves | 2334 | 80 | |
| | | | | | | | | | |
| | | | | | | | | | |

installs on credenza
unfinished back

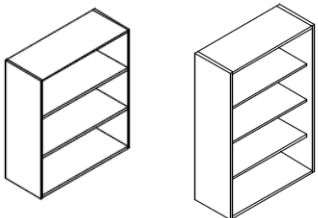
| | | | | | | | | | |
|--------------------------------------|---|---------------|------------------|----|------------------|----------------|------|-----|--|
| Upper Storage w/ Open Shelves |  | XSUS12-143041 | 14 $\frac{1}{4}$ | 30 | 41 $\frac{1}{4}$ | 2 adj. shelves | 2241 | 85 | |
| | | XSUS12-143641 | 14 $\frac{1}{4}$ | 36 | 41 $\frac{1}{4}$ | 2 adj. shelves | 2337 | 97 | |
| | | XSUS13-143053 | 14 $\frac{1}{4}$ | 30 | 53 $\frac{1}{4}$ | 3 adj. shelves | 2553 | 108 | |
| | | XSUS13-143653 | 14 $\frac{1}{4}$ | 36 | 53 $\frac{1}{4}$ | 3 adj. shelves | 2672 | 123 | |
| | | | | | | | | | |
| | | | | | | | | | |

installs on credenza
unfinished back

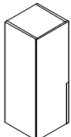
| | | | | | | | | | |
|-------------------------------------|--|-----------------|----|------------------|------------------|----------------|------|-----|--|
| Upper Storage w/ Hinged Door |  | XSUT12-151641-L | 15 | 15 $\frac{3}{4}$ | 41 $\frac{1}{4}$ | 2 adj. shelves | 2547 | 73 | |
| | | XSUT12-151941-L | 15 | 18 $\frac{3}{4}$ | 41 $\frac{1}{4}$ | 2 adj. shelves | 2617 | 82 | |
| | | XSUT13-151653-L | 15 | 15 $\frac{3}{4}$ | 53 $\frac{1}{4}$ | 3 adj. shelves | 2853 | 93 | |
| | | XSUT13-151953-L | 15 | 18 $\frac{3}{4}$ | 53 $\frac{1}{4}$ | 3 adj. shelves | 2946 | 105 | |
| | | | | | | | | | |
| | | | | | | | | | |

installs on credenza
unfinished back
specify Left or Right hinged door

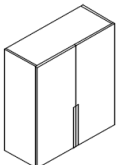
| | | | | | | | | | |
|--------------------------------------|---|---------------|----|----|------------------|----------------|------|-----|--|
| Upper Storage w/ Hinged Doors |  | XSUT12-153041 | 15 | 30 | 41 $\frac{1}{4}$ | 2 adj. shelves | 2879 | 114 | |
| | | XSUT12-153641 | 15 | 36 | 41 $\frac{1}{4}$ | 2 adj. shelves | 3021 | 132 | |
| | | XSUT13-153053 | 15 | 30 | 53 $\frac{1}{4}$ | 3 adj. shelves | 3277 | 146 | |
| | | XSUT13-153653 | 15 | 36 | 53 $\frac{1}{4}$ | 3 adj. shelves | 3456 | 169 | |
| | | | | | | | | | |
| | | | | | | | | | |

installs on credenza
unfinished back

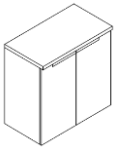
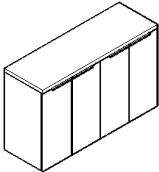
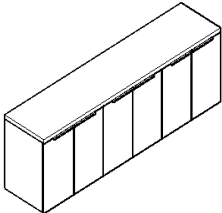
| Description | | Model Number | Depth | Width | Height | Notes | Price (US\$) | Weight (lbs.) |
|--|--|--------------|-------|-------|--------|-------|--------------|---------------|
| Full Storage Cabinet |  | XSHU11-2030 | 20 | 30 | 29¼ | | 2136 | 101 |
| | | XSHU11-2036 | 20 | 36 | 29¼ | | 2333 | 116 |
| | | XSHU11-2042 | 20 | 42 | 29¼ | | 2531 | 131 |
| | | | | | | | | |
| 1 adj. shelf unfinished back | | | | | | | | |
| Full Storage Cabinet |  | XSHU21-2060 | 20 | 60 | 29¼ | | 3610 | 189 |
| | | XSHU21-2072 | 20 | 72 | 29¼ | | 1005 | 220 |
| | | | | | | | | |
| 2 bay, 1 adj. shelf ea. bay unfinished back | | | | | | | | |
| Full Storage Cabinet |  | XSHU31-2084 | 20 | 84 | 29¼ | | 4889 | 262 |
| | | XSHU31-2090 | 20 | 90 | 29¼ | | 5088 | 278 |
| | | XSHU31-2096 | 20 | 96 | 29¼ | | 5284 | 293 |
| | | | | | | | | |
| 3 bay, 1 adj. shelf ea. bay unfinished back | | | | | | | | |

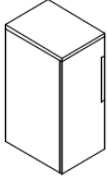
| Description | | Model Number | Depth | Width | Height | Notes | Price (US\$) | Weight (lbs.) | | |
|----------------------------|---|---|-------|-------|--------|----------------|--------------|---------------|--|--|
| Hinged Door Storage |  | XSHU12-151643-L | 15 | 15¾ | 42¾ | 2 adj. shelves | 2127 | 70 | | |
| | | XSHU12-151943-L | 15 | 18¾ | 42¾ | 2 adj. shelves | 2235 | 78 | | |
| | | XSHU12-201643-L | 20 | 15¾ | 42¾ | 2 adj. shelves | 2325 | 88 | | |
| | | XSHU12-201943-L | 20 | 18¾ | 42¾ | 2 adj. shelves | 2448 | 98 | | |
| | | XSHU12-241643-L | 24 | 15¾ | 42¾ | 2 adj. shelves | 2485 | 103 | | |
| | | XSHU12-241943-L | 24 | 18¾ | 42¾ | 2 adj. shelves | 2618 | 114 | | |
| | | XSHU13-151655-L | 15 | 15¾ | 55 | 3 adj. shelves | 2707 | 86 | | |
| | | XSHU13-151955-L | 15 | 18¾ | 55 | 3 adj. shelves | 2836 | 96 | | |
| | | XSHU13-201655-L | 20 | 15¾ | 55 | 3 adj. shelves | 2942 | 109 | | |
| | | XSHU13-201955-L | 20 | 18¾ | 55 | 3 adj. shelves | 3083 | 120 | | |
| | | XSHU13-241655-L | 24 | 15¾ | 55 | 3 adj. shelves | 3130 | 127 | | |
| | | XSHU13-241955-L | 24 | 18¾ | 55 | 3 adj. shelves | 3284 | 140 | | |
| | | includes full 1½ "overlay top unfinished back specify Left or Right hinged door | | | | | | | | |

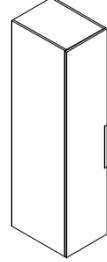
| | | | | | | | | | | |
|----------------------------|--|--|----|-----|-----|----------------|------|-----|--|--|
| Hinged Door Storage |  | XSHU14-241671-L | 24 | 15¾ | 70½ | 4 adj. shelves | 3882 | 156 | | |
| | | XSHU14-241971-L | 24 | 18¾ | 70½ | 4 adj. shelves | 4063 | 172 | | |
| | | XSHU15-241683-L | 24 | 15¾ | 82½ | 5 adj. shelves | 4524 | 180 | | |
| | | XSHU15-241983-L | 24 | 18¾ | 82½ | 5 adj. shelves | 4732 | 198 | | |
| | | unfinished back Specify Left or Right hinged door | | | | | | | | |

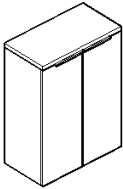
| Description | | Model Number | Depth | Width | Height | Notes | Price (US\$) | Weight (lbs.) | | |
|----------------------------|---|--|-------|-------|--------|----------------|--------------|---------------|--|--|
| Hinged Door Storage |  | XSHU12-153043 | 15 | 30 | 42¾ | 2 adj. shelves | 2647 | 107 | | |
| | | XSHU12-153643 | 15 | 36 | 42¾ | 2 adj. shelves | 2872 | 123 | | |
| | | XSHU12-203043 | 20 | 30 | 42¾ | 2 adj. shelves | 2896 | 134 | | |
| | | XSHU12-203643 | 20 | 36 | 42¾ | 2 adj. shelves | 3142 | 153 | | |
| | | XSHU12-243043 | 24 | 30 | 42¾ | 2 adj. shelves | 3096 | 155 | | |
| | | XSHU12-243643 | 24 | 36 | 42¾ | 2 adj. shelves | 3357 | 177 | | |
| | | XSHU13-153055 | 15 | 30 | 55 | 3 adj. shelves | 3320 | 131 | | |
| | | XSHU13-153655 | 15 | 36 | 55 | 3 adj. shelves | 3578 | 151 | | |
| | | XSHU13-203055 | 20 | 30 | 55 | 3 adj. shelves | 3619 | 164 | | |
| | | XSHU13-203655 | 20 | 36 | 55 | 3 adj. shelves | 3905 | 187 | | |
| | | XSHU13-243055 | 24 | 30 | 55 | 3 adj. shelves | 3853 | 189 | | |
| | | XSHU13-243655 | 24 | 36 | 55 | 3 adj. shelves | 4162 | 216 | | |
| | | includes full 1½" overlay top unfinished back | | | | | | | | |

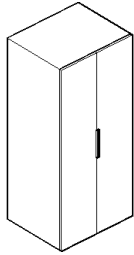
| | | | | | | | | |
|----------------------------|--|---------------|----|----|-----|----------------|------|-----|
| Hinged Door Storage |  | XSHU14-243071 | 24 | 30 | 70½ | 4 adj. shelves | 4731 | 230 |
| | | XSHU14-243671 | 24 | 36 | 70½ | 4 adj. shelves | 5097 | 262 |

unfinished back

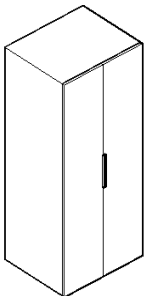
| | | | | | | | | |
|----------------------------|---|---------------|----|----|-----|----------------|------|-----|
| Hinged Door Storage |  | XSHU15-243083 | 24 | 30 | 82½ | 5 adj. shelves | 5490 | 265 |
| | | XSHU15-243683 | 24 | 36 | 82½ | 5 adj. shelves | 5905 | 301 |

unfinished back

| Description | Model Number | Depth | Width | Height | Notes | Price (US\$) | Weight (lbs.) |
|-----------------|-----------------|-------|-------|--------|--------------------|--------------|---------------|
| Wardrobe | XSCU11-241671-L | 24 | 15¾ | 70½ | coat bar & 1 shelf | 2991 | 148 |
| | XSCU11-241971-L | 24 | 18¾ | 70½ | coat bar & 1 shelf | 3136 | 162 |
| | XSCU11-241683-L | 24 | 15¾ | 82½ | coat bar & 1 shelf | 3305 | 168 |
| | XSCU11-241983-L | 24 | 18¾ | 82½ | coat bar & 1 shelf | 3468 | 184 |



unfinished back
specify Left or Right hinged door

| | | | | | | | |
|----------------------|---------------|----|----|-----|--------------------|------|-----|
| Full Wardrobe | XSCU11-243071 | 24 | 30 | 70½ | coat bar & 1 shelf | 3681 | 215 |
| | XSCU11-243671 | 24 | 36 | 70½ | coat bar & 1 shelf | 3974 | 244 |
| | XSCU11-243083 | 24 | 30 | 82½ | coat bar & 1 shelf | 4046 | 242 |
| | XSCU11-243683 | 24 | 36 | 82½ | coat bar & 1 shelf | 4369 | 274 |

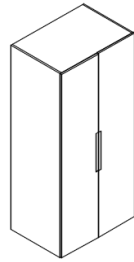

unfinished back

| | | | | | | | |
|-------------------------------------|---------------|----|----|-----|------------------------------|------|-----|
| Half Wardrobe / Half Storage | XSDU24-243071 | 24 | 30 | 70½ | 4 adj. shelves in right half | 5558 | 295 |
| | XSDU24-243671 | 24 | 36 | 70½ | 4 adj. shelves in right half | 5927 | 333 |
| | XSDU25-243083 | 24 | 30 | 82½ | 5 adj. shelves in right half | 6383 | 343 |
| | XSDU25-243683 | 24 | 36 | 82½ | 5 adj. shelves in right half | 6805 | 387 |

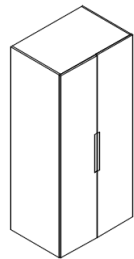

coat bar & 1 hat shelf in left half
unfinished back

| Description | Model Number | Depth | Width | Height | Notes | Price (US\$) | Weight (lbs.) |
|---------------------------------|------------------|-------|-------|--------|--|--------------|---------------|
| Combination File/Storage | XSSU122-241971-R | 24 | 18¾ | 70½ | 2 adj. shelves above 2 legal files below | 4958 | 211 |
| | XSSU132-241983-R | 24 | 18¾ | 82½ | 3 adj. shelves above 2 legal files below | 5631 | 242 |

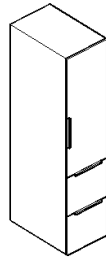

unfinished back
specify Left or Right hinged door

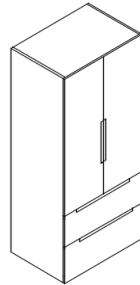

| | | | | | | | |
|---------------------------------|----------------|----|----|-----|---|------|-----|
| Combination File/Storage | XSSU122-243071 | 24 | 30 | 70½ | 2 adj. shelves above 2 lateral files below | 5563 | 275 |
| | XSSU122-243671 | 24 | 36 | 70½ | 2 adj. shelves above 2 lateral files below | 5889 | 310 |
| | XSSU132-243083 | 24 | 30 | 82½ | 3 adj. shelves above 2 lateral files below | 6319 | 317 |
| | XSSU132-243683 | 24 | 36 | 82½ | 3 adj. shelves above 2 lateral files below. | 6698 | 358 |

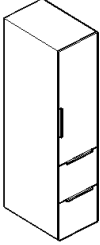
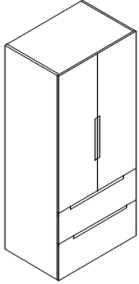
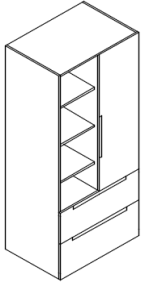

unfinished back

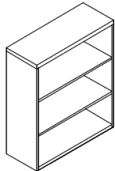
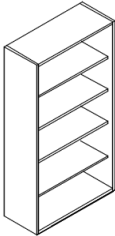
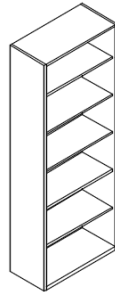
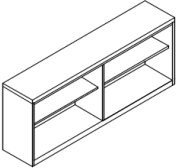
| Description | | Model Number | Depth | Width | Height | Notes | Price (US\$) | Weight (lbs.) |
|---|---|------------------|-------|-------|--------|---|--------------|---------------|
| Combination File/Wardrobe |  | XSQU102-241971-R | 24 | 18¾ | 70½ | . | 4412 | 192 |
| | | XSQU112-241983-R | 24 | 18¾ | 82½ | . | 5068 | 223 |
| coat bar & hat shelf above 2 legal width file drawers unfinished back Specify Left or Right hinged door | | | | | | | | |
| Combination File/Wardrobe |  | XSQU102-243071 | 24 | 30 | 70½ | two 30" w file dwrs. | 4951 | 245 |
| | | XSQU102-243671 | 24 | 36 | 70½ | two 36" w file dwrs. | 5240 | 274 |
| | | XSQU112-243083 | 24 | 30 | 82½ | two 30" w file dwrs. | 5693 | 287 |
| | | XSQU112-243683 | 24 | 36 | 82½ | two 36" w file dwrs. | 6035 | 322 |
| coat bar & hat shelf above unfinished back | | | | | | | | |
| Combination File/Wardrobe/Open Shelves |  | XSKU222-243071-R | 24 | 30 | 70½ | coat bar & 2 open shelves above two 30" w. file dwrs. | 6473 | 310 |
| | | XSKU222-243671-R | 24 | 36 | 70½ | coat bar & 2 open shelves above two 36" w. file dwrs. | 6815 | 345 |
| | | XSKU232-243083-R | 24 | 30 | 82½ | coat bar & 3 open shelves above two 30" w. file dwrs. | 7298 | 358 |
| | | XSKU232-243683-R | 24 | 36 | 82½ | coat bar & 3 open shelves above two 30" w. file dwrs. | 7693 | 399 |
| unfinished back specify L or Right | | | | | | | | |

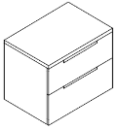
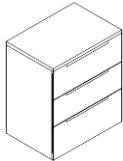
| Description | | Model Number | Depth | Width | Height | Notes | Price (US\$) | Weight (lbs.) |
|--|---|---------------|-------|-------|--------|-----------------------------------|--------------|---------------|
| Bookcase full 1½" overlay top unfinished back |  | XSBU12-153043 | 15 | 30 | 42¾ | 2 adj. shelves | 1804 | 98 |
| | | XSBU12-153643 | 15 | 36 | 42¾ | 2 adj. shelves | 1910 | 112 |
| | | XSBU13-153055 | 15 | 30 | 55 | 3 adj. shelves | 2123 | 122 |
| | | XSBU13-153655 | 15 | 36 | 55 | 3 adj. shelves | 2255 | 139 |
| Bookcase no overlay top unfinished back |  | XSBU14-153071 | 15 | 30 | 70½ | 4 adj. shelves | 2480 | 151 |
| | | XSBU14-153671 | 15 | 36 | 70½ | 4 adj. shelves | 2642 | 173 |
| Bookcase no overlay top unfinished back |  | XSBU15-153083 | 15 | 30 | 82½ | 5 adj. shelves | 2798 | 176 |
| | | XSBU15-153683 | 15 | 36 | 82½ | 5 adj. shelves | 2987 | 200 |
| Bookcase one adj. shelf ea. bay full 1½" overlay top unfinished back |  | XSBU21-156029 | 15 | 60 | 29¼ | both openings @ 11-7/8" clear ht. | 2396 | 132 |
| | | XSBU21-157229 | 15 | 72 | 29¼ | both openings @ 11-7/8" clear ht. | 2555 | 153 |

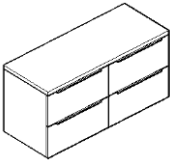
| Description | | Model Number | Depth | Width | Height | Notes | Price (US\$) | Weight (lbs.) |
|---|---|----------------|-------|-------|--------|-------|--------------|---------------|
| Freestanding File Storage |  | XSFU102-203029 | 20 | 30 | 29¼ | | 2499 | 118 |
| | | XSFU102-203629 | 20 | 36 | 29¼ | | 2599 | 131 |
| | | XSFU102-243029 | 24 | 30 | 29¼ | | 2574 | 132 |
| | | XSFU102-243629 | 24 | 36 | 29¼ | | 2678 | 147 |
| full 1½" overlay top unfinished back | | | | | | | | |
| Freestanding File Storage |  | XSFU103-203042 | 20 | 30 | 42¼ | | 3402 | 152 |
| | | XSFU103-203642 | 20 | 36 | 42¼ | | 3519 | 167 |
| | | XSFU103-243042 | 24 | 30 | 42¼ | | 3493 | 168 |
| | | XSFU103-243642 | 24 | 36 | 42¼ | | 3614 | 185 |
| full 1½" overlay top unfinished back | | | | | | | | |
| Freestanding File Storage |  | XSFU104-203055 | 20 | 30 | 55 | | 4308 | 186 |
| | | XSFU104-203655 | 20 | 36 | 55 | | 4441 | 202 |
| | | XSFU104-243055 | 24 | 30 | 55 | | 4413 | 204 |
| | | XSFU104-243655 | 24 | 36 | 55 | | 4550 | 222 |
| full 1½" overlay top unfinished back | | | | | | | | |
| Freestanding File Storage |  | XSFU202-206029 | 20 | 60 | 29¼ | | 4644 | 236 |
| | | XSFU202-207229 | 20 | 72 | 29¼ | | 4861 | 262 |
| | | XSFU202-246029 | 24 | 60 | 29¼ | | 4764 | 264 |
| | | XSFU202-247229 | 24 | 72 | 29¼ | | 4992 | 294 |
| full 1½" overlay top unfinished back | | | | | | | | |

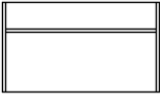
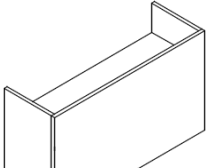
| Description | Model Number | Depth | Width | Height | Notes | Price (US\$) | Weight (lbs.) |
|--|-----------------|-------|-------|--------|-------|--------------|---------------|
| Gallery Desk Shell   | XD0R-3060-0-GL2 | 30 | 60 | 41¼ | | 4161 | 233 |
| | XD0R-3066-0-GL2 | 30 | 66 | 41¼ | | 4331 | 248 |
| | XD0R-3072-0-GL2 | 30 | 72 | 41¼ | | 4497 | 263 |
| | XD0R-3078-0-GL2 | 30 | 78 | 41¼ | | 4664 | 278 |
| | XD0R-3084-0-GL2 | 30 | 84 | 41¼ | | 4831 | 293 |
| | XD0R-3090-0-GL2 | 30 | 90 | 41¼ | | 4995 | 307 |
| | XD0R-3096-0-GL2 | 30 | 96 | 41¼ | | 5165 | 322 |

includes two grommets

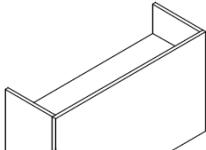
| | | | | | | | |
|---|------------------|----|----|-----|--|------|-----|
| Gallery Desk w/ Single Pedestal   | XD0R-3060-CR-GL2 | 30 | 60 | 41¼ | | 5765 | 313 |
| | XD0R-3066-CR-GL2 | 30 | 66 | 41¼ | | 5935 | 328 |
| | XD0R-3072-CR-GL2 | 30 | 72 | 41¼ | | 6101 | 343 |
| | XD0R-3078-CR-GL2 | 30 | 78 | 41¼ | | 6268 | 358 |
| | XD0R-3084-CR-GL2 | 30 | 84 | 41¼ | | 6432 | 373 |
| | XD0R-3090-CR-GL2 | 30 | 90 | 41¼ | | 6599 | 387 |
| | XD0R-3096-CR-GL2 | 30 | 96 | 41¼ | | 6765 | 402 |

legal width b/b/f pedestal
includes two grommets
specify Left or Right (seated)

| | | | | | | | |
|---|-------------------|----|----|------|--------------------------------------|------|-----|
| Gallery Desk w/ Two Pedestals   | XD0R-3066-AKB-GL2 | 30 | 66 | 41 ¼ | letter width b/b/f and f/f pedestals | 7535 | 408 |
| | XD0R-3072-CKD-GL2 | 30 | 72 | 41 ¼ | legal width b/b/f and f/f pedestals | 7705 | 423 |
| | XD0R-3078-CKD-GL2 | 30 | 78 | 41 ¼ | legal width b/b/f and f/f pedestals | 7868 | 438 |
| | XD0R-3084-CKD-GL2 | 30 | 84 | 41 ¼ | legal width b/b/f and f/f pedestals | 8035 | 453 |
| | XD0R-3090-CKD-GL2 | 30 | 90 | 41 ¼ | legal width b/b/f and f/f pedestals | 8199 | 467 |
| | XD0R-3096-CKD-GL2 | 30 | 96 | 41 ¼ | legal width b/b/f and f/f pedestals | 8369 | 482 |

includes two grommets

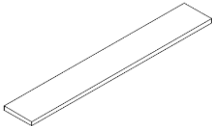
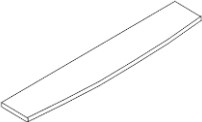
| Description | | Model Number | Depth | Width | Height | Notes | Price (US\$) | Weight (lbs.) |
|--|---|---------------|-------|-------|--------|-------|--------------|---------------|
| Gallery Overlay Transaction Top |  | XWA11-11662 | 11 | 66 | 1½ | | 532 | 25 |
| | | XWA11-11722 | 11 | 72 | 1½ | | 549 | 28 |
| | | XWA11-11782 | 11 | 78 | 1½ | | 568 | 30 |
| | | XWA11-11842 | 11 | 84 | 1½ | | 585 | 32 |
| | | XWA11-11902 | 11 | 90 | 1½ | | 605 | 34 |
| | | XWA11-11962 | 11 | 96 | 1½ | | 621 | 37 |
| | | XWA11-111022 | 11 | 102 | 1½ | | 641 | 39 |
| | | XWA11-111082 | 11 | 108 | 1½ | | 658 | 41 |
| Gallery Bow Front Overlay Transaction Top |  | XWA11F-13662 | 13 | 66 | 1½ | | 595 | 30 |
| | | XWA11F-14722 | 13½ | 72 | 1½ | | 631 | 35 |
| | | XWA11F-14782 | 14 | 78 | 1½ | | 655 | 38 |
| | | XWA11F-15842 | 14½ | 84 | 1½ | | 694 | 44 |
| | | XWA11F-15902 | 15 | 90 | 1½ | | 721 | 47 |
| | | XWA11F-16962 | 15½ | 96 | 1½ | | 761 | 53 |
| | | XWA11F-161022 | 16 | 102 | 1½ | | 787 | 57 |
| | | XWA11F-171082 | 16½ | 108 | 1½ | | 833 | 64 |

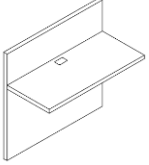
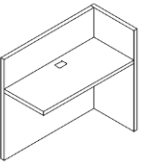
| Description | | Model Number | Depth | Width | Height | Notes | Price (US\$) | Weight (lbs.) | | |
|--|---|--|---|-----------------|--------|-------|--------------|---------------|------|-----|
| Gallery Bridge |  | XB0R-2036-0-GL1 | 20 | 36 | 41¼ | | 1742 | 76 | | |
| | | XB0R-2042-0-GL1 | 20 | 42 | 41¼ | | 1899 | 89 | | |
| | | XB0R-2048-0-GL1 | 20 | 48 | 41¼ | | 2057 | 102 | | |
| | | XB0R-2054-0-GL1 | 20 | 54 | 41¼ | | 2210 | 114 | | |
| | | XB0R-2436-0-GL1 | 24 | 36 | 41¼ | | 1823 | 81 | | |
| | | XB0R-2442-0-GL1 | 24 | 42 | 41¼ | | 1984 | 95 | | |
| | | XB0R-2448-0-GL1 | 24 | 48 | 41¼ | | 2148 | 108 | | |
| | | XB0R-2454-0-GL1 | 24 | 54 | 41¼ | | 2305 | 122 | | |
| | | XB0R-3036-0-GL1 | 30 | 36 | 41¼ | | 1945 | 89 | | |
| | | XB0R-3042-0-GL1 | 30 | 42 | 41¼ | | 2115 | 104 | | |
| | | XB0R-3048-0-GL1 | 30 | 48 | 41¼ | | 2282 | 118 | | |
| | | XB0R-3054-0-GL1 | 30 | 54 | 41¼ | | 2445 | 133 | | |
| | | includes one grommet – center of kneespace | | | | | | | | |
| | | Gallery Return Shell |  | XR0R-2036-R-GL1 | 20 | 36 | 41¼ | | 2391 | 105 |
| XR0R-2042-R-GL1 | 20 | | | 42 | 41¼ | | 2551 | 117 | | |
| XR0R-2048-R-GL1 | 20 | | | 48 | 41¼ | | 2706 | 130 | | |
| XR0R-2054-R-GL1 | 20 | | | 54 | 41¼ | | 2862 | 143 | | |
| XR0R-2060-R-GL1 | 20 | | | 60 | 41¼ | | 3017 | 156 | | |
| XR0R-2436-R-GL1 | 24 | | | 36 | 41¼ | | 2508 | 115 | | |
| XR0R-2442-R-GL1 | 24 | | | 42 | 41¼ | | 2670 | 129 | | |
| XR0R-2448-R-GL1 | 24 | | | 48 | 41¼ | | 2833 | 143 | | |
| XR0R-2454-R-GL1 | 24 | | | 54 | 41¼ | | 2993 | 156 | | |
| XR0R-2460-R-GL1 | 24 | | | 60 | 41¼ | | 3151 | 170 | | |
| XR0R-3042-R-GL1 | 30 | | | 42 | 41¼ | | 2853 | 146 | | |
| XR0R-3048-R-GL1 | 30 | | | 48 | 41¼ | | 3017 | 161 | | |
| XR0R-3054-R-GL1 | 30 | | | 54 | 41¼ | | 3184 | 176 | | |
| XR0R-3060-R-GL1 | 30 | | | 60 | 41¼ | | 3347 | 19 | | |
| includes one grommet – center of kneespace specify Left or Right (seated) | | | | | | | | | | |

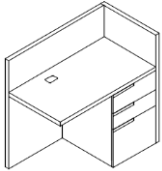
| Description | | Model Number | Depth | Width | Height | Notes | Price (US\$) | Weight (lbs.) |
|---------------------------------------|---|------------------|-------|-------|--------|--------------------|--------------|---------------|
| Gallery Return w/ one pedestal |  | XR0R-2036-AR-GL1 | 20 | 36 | 41¼ | letter width b/b/f | 3866 | 185 |
| | | XR0R-2042-AR-GL1 | 20 | 42 | 41¼ | letter width b/b/f | 4022 | 197 |
| | | XR0R-2048-CR-GL1 | 20 | 48 | 41¼ | legal width b/b/f | 4181 | 210 |
| | | XR0R-2054-CR-GL1 | 20 | 54 | 41¼ | legal width b/b/f | 4333 | 223 |
| | | XR0R-2060-CR-GL1 | 20 | 60 | 41¼ | legal width b/b/f | 4492 | 236 |
| | | XR0R-2436-AR-GL1 | 24 | 36 | 41¼ | letter width b/b/f | 4046 | 195 |
| | | XR0R-2442-AR-GL1 | 24 | 42 | 41¼ | letter width b/b/f | 4208 | 209 |
| | | XR0R-2448-CR-GL1 | 24 | 48 | 41¼ | legal width b/b/f | 4371 | 223 |
| | | XR0R-2454-CR-GL1 | 24 | 54 | 41¼ | legal width b/b/f | 4528 | 236 |
| | | XR0R-2460-CR-GL1 | 24 | 60 | 41¼ | legal width b/b/f | 4688 | 250 |
| | | XR0R-3042-AR-GL1 | 30 | 42 | 41¼ | letter width b/b/f | 4457 | 226 |
| | | XR0R-3048-CR-GL1 | 30 | 48 | 41¼ | legal width b/b/f | 4621 | 241 |
| | | XR0R-3054-CR-GL1 | 30 | 54 | 41¼ | legal width b/b/f | 4788 | 256 |
| | | XR0R-3060-CR-GL1 | 30 | 60 | 41¼ | legal width b/b/f | 4951 | 271 |

includes one grommet – center of kneespace
specify Left or Right (seated)

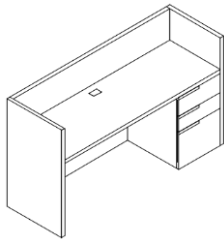
| | | | | | | | | |
|---|--|------------------|----|----|-----|--|------|-----|
| Gallery Credenza w/ one pedestal |  | XC0R-2060-CR-GL1 | 20 | 60 | 41¼ | | 5141 | 264 |
| | | XC0R-2066-CR-GL1 | 20 | 66 | 41¼ | | 5299 | 277 |
| | | XC0R-2072-CR-GL1 | 20 | 72 | 41¼ | | 5456 | 289 |
| | | XC0R-2078-CR-GL1 | 20 | 78 | 41¼ | | 5614 | 302 |
| | | XC0R-2084-CR-GL1 | 20 | 84 | 41¼ | | 5767 | 315 |
| | | XC0R-2460-CR-GL1 | 24 | 60 | 41¼ | | 5374 | 284 |
| | | XC0R-2466-CR-GL1 | 24 | 66 | 41¼ | | 5534 | 297 |
| | | XC0R-2472-CR-GL1 | 24 | 72 | 41¼ | | 5698 | 311 |
| | | XC0R-2478-CR-GL1 | 24 | 78 | 41¼ | | 5858 | 324 |
| | | XC0R-2484-CR-GL1 | 24 | 84 | 41¼ | | 6018 | 338 |

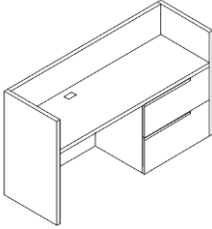

legal width b/b/f
includes one grommet – center of kneespace
specify Left or Right (seated)

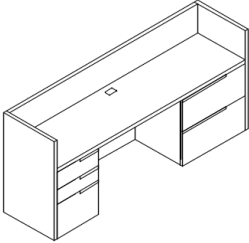

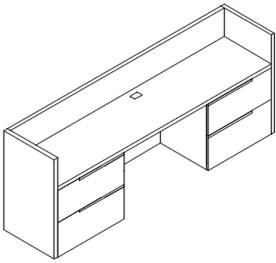
| Description | | Model Number | Depth | Width | Height | Notes | Price (US\$) | Weight (lbs.) |
|---|---|------------------|-------|-------|--------|-------|--------------|---------------|
| Gallery Credenza w/ one pedestal |  | XC0R-2060-ER-GL1 | 20 | 60 | 41¼ | | 5514 | 284 |
| | | XC0R-2066-ER-GL1 | 20 | 66 | 41¼ | | 5672 | 297 |
| | | XC0R-2072-ER-GL1 | 20 | 72 | 41¼ | | 5829 | 309 |
| | | XC0R-2078-ER-GL1 | 20 | 78 | 41¼ | | 5987 | 322 |
| | | XC0R-2084-ER-GL1 | 20 | 84 | 41¼ | | 6140 | 335 |
| | | XC0R-2460-ER-GL1 | 24 | 60 | 41¼ | | 5736 | 304 |
| | | XC0R-2466-ER-GL1 | 24 | 66 | 41¼ | | 5896 | 317 |
| | | XC0R-2472-ER-GL1 | 24 | 72 | 41¼ | | 6059 | 331 |
| | | XC0R-2478-ER-GL1 | 24 | 78 | 41¼ | | 6219 | 344 |
| | | XC0R-2484-ER-GL1 | 24 | 84 | 41¼ | | 6380 | 358 |
| includes one grommet – center of kneespace 30" w lateral file pedestal specify Left or Right (seated) | | | | | | | | |

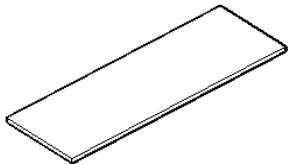

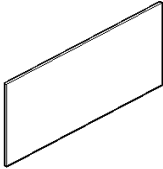
| | | | | | | | | |
|--|---|--|----|----|-----|--|------|-----|
| Gallery Credenza w/ two pedestals |  | XC0R-2072-CKE-GL1 | 20 | 72 | 41¼ | | 7304 | 389 |
| | | XC0R-2078-CKE-GL1 | 20 | 78 | 41¼ | | 7463 | 402 |
| | | XC0R-2084-CKE-GL1 | 20 | 84 | 41¼ | | 7615 | 415 |
| | | XC0R-2472-CKE-GL1 | 24 | 72 | 41¼ | | 7602 | 420 |
| | | XC0R-2478-CKE-GL1 | 24 | 78 | 41¼ | | 7765 | 424 |
| | | XC0R-2484-CKE-GL1 | 24 | 84 | 41¼ | | 7922 | 438 |
| | | includes one grommet – center of kneespace 30" w lateral file pedestal + legal width b/b/f pedestal specify Left or Right (seated) | | | | | | |

| | | | | | | | | |
|--|---|-------------------|----|----|-----|--|------|-----|
| Gallery Credenza w/ two pedestals |  | XC0R-2084-EKE-GL1 | 20 | 84 | 41¼ | | 7993 | 435 |
| | | XC0R-2484-EKE-GL1 | 24 | 84 | 41¼ | | 8293 | 458 |
| includes one grommet – center of kneespace two 30" w lateral file pedestals specify Left or Right (seated) | | | | | | | | |

| Description | Model Number | Depth | Width | Height | Notes | Price (US\$) | Weight (lbs.) |
|---|---------------|-------|-------|--------|-------|--------------|---------------|
| Work surface  | XWT11S-30162 | 30 | 16 | 1½ | | 722 | 17 |
| | XWT11S-30192 | 30 | 19 | 1½ | | 758 | 20 |
| | XWT11S-30302 | 30 | 30 | 1½ | | 907 | 31 |
| | XWT11S-30362 | 30 | 36 | 1½ | | 987 | 38 |
| | XWT11S-30422 | 30 | 42 | 1½ | | 1069 | 44 |
| | XWT11S-30482 | 30 | 48 | 1½ | | 1150 | 50 |
| | XWT11S-30542 | 30 | 54 | 1½ | | 1233 | 56 |
| | XWT11S-30602 | 30 | 60 | 1½ | | 1309 | 63 |
| | XWT11S-30662 | 30 | 66 | 1½ | | 1391 | 69 |
| | XWT11S-30722 | 30 | 72 | 1½ | | 1474 | 75 |
| | XWT11S-30782 | 30 | 78 | 1½ | | 1551 | 81 |
| | XWT11S-30842 | 30 | 84 | 1½ | | 1632 | 88 |
| | XWT11S-30902 | 30 | 90 | 1½ | | 1713 | 94 |
| | XWT11S-30962 | 30 | 96 | 1½ | | 1792 | 100 |
| | XWT11S-301022 | 30 | 102 | 1½ | | 1875 | 106 |
| | XWT11S-301082 | 30 | 108 | 1½ | | 1954 | 113 |
| | XWT11S-301142 | 30 | 114 | 1½ | | 2037 | 119 |
| | XWT11S-301202 | 30 | 120 | 1½ | | 2116 | 125 |
| | XWT11S-301262 | 30 | 126 | 1½ | | 2197 | 131 |
| | XWT11S-301322 | 30 | 132 | 1½ | | 2278 | 138 |
| | XWT11S-301382 | 30 | 138 | 1½ | | 2356 | 144 |
| | XWT11S-301442 | 30 | 144 | 1½ | | 2438 | 150 |
| | XWT11S-36162 | 36 | 16 | 1½ | | 792 | 20 |
| | XWT11S-36192 | 36 | 19 | 1½ | | 834 | 24 |
| | XWT11S-36302 | 36 | 30 | 1½ | | 993 | 38 |
| | XWT11S-36362 | 36 | 36 | 1½ | | 1082 | 45 |
| | XWT11S-36422 | 36 | 42 | 1½ | | 1167 | 53 |
| | XWT11S-36482 | 36 | 48 | 1½ | | 1256 | 60 |
| | XWT11S-36542 | 36 | 54 | 1½ | | 1339 | 68 |
| | XWT11S-36602 | 36 | 60 | 1½ | | 1428 | 75 |
| | XWT11S-36662 | 36 | 66 | 1½ | | 1513 | 83 |
| | XWT11S-36722 | 36 | 72 | 1½ | | 1601 | 90 |
| | XWT11S-36782 | 36 | 78 | 1½ | | 1685 | 98 |
| | XWT11S-36842 | 36 | 84 | 1½ | | 1773 | 105 |
| | XWT11S-36902 | 36 | 90 | 1½ | | 1859 | 113 |
| | XWT11S-36962 | 36 | 96 | 1½ | | 1948 | 120 |
| | XWT11S-361022 | 36 | 102 | 1½ | | 2031 | 128 |
| | XWT11S-361082 | 36 | 108 | 1½ | | 2120 | 135 |
| | XWT11S-361142 | 36 | 114 | 1½ | | 2209 | 143 |
| | XWT11S-361202 | 36 | 120 | 1½ | | 2293 | 150 |
| XWT11S-361262 | 36 | 126 | 1½ | | 2381 | 158 | |
| XWT11S-361322 | 36 | 132 | 1½ | | 2465 | 165 | |
| XWT11S-361382 | 36 | 138 | 1½ | | 2554 | 173 | |
| XWT11S-361442 | 36 | 144 | 1½ | | 2640 | 180 | |

| Description | | Model Number | Depth | Width | Height | Notes | Price (US\$) | Weight (lbs.) |
|----------------------|---|--------------|-------|-------|--------|-------|--------------|---------------|
| Modesty Panel |  | XWM2-13027 | ¾ | 30 | 27¼ | | 431 | 17 |
| | | XWM2-13627 | ¾ | 36 | 27¼ | | 482 | 20 |
| | | XWM2-14227 | ¾ | 42 | 27¼ | | 531 | 24 |
| | | XWM2-14827 | ¾ | 48 | 27¼ | | 580 | 27 |
| | | XWM2-15427 | ¾ | 54 | 27¼ | | 629 | 30 |
| | | XWM2-16027 | ¾ | 60 | 27¼ | | 681 | 34 |
| | | XWM2-16627 | ¾ | 66 | 27¼ | | 727 | 37 |
| | | XWM2-17227 | ¾ | 72 | 27¼ | | 776 | 41 |
| | | XWM2-17827 | ¾ | 78 | 27¼ | | 825 | 44 |
| | | XWM2-18427 | ¾ | 84 | 27¼ | | 874 | 47 |
| | | XWM2-19027 | ¾ | 90 | 27¼ | | 923 | 51 |
| | | XWM2-19627 | ¾ | 96 | 27¼ | | 972 | 54 |
| | | XWM2-110227 | ¾ | 102 | 27¼ | | 1021 | 57 |
| | | XWM2-110827 | ¾ | 108 | 27¼ | | 1075 | 61 |
| | | XWM2-111427 | ¾ | 114 | 27¼ | | 1120 | 64 |
| | | XWM2-112027 | ¾ | 120 | 27¼ | | 1171 | 68 |
| | | XWM2-112627 | ¾ | 126 | 27¼ | | 1220 | 71 |
| | | XWM2-113227 | ¾ | 132 | 27¼ | | 1269 | 74 |
| | | XWM2-113827 | ¾ | 138 | 27¼ | | 1316 | 78 |
| XWM2-114427 | ¾ | 144 | 27¼ | | 1366 | 81 | | |
| Keel |  | XWM2-1483 | ¾ | 48 | 3 | | 371 | 3 |
| | | XWM2-1543 | ¾ | 54 | 3 | | 394 | 3 |
| | | XWM2-1603 | ¾ | 60 | 3 | | 419 | 4 |
| | | XWM2-1663 | ¾ | 66 | 3 | | 442 | 4 |
| | | XWM2-1723 | ¾ | 72 | 3 | | 464 | 5 |
| | | XWM2-1783 | ¾ | 78 | 3 | | 487 | 5 |
| | | XWM2-1843 | ¾ | 84 | 3 | | 510 | 5 |
| | | XWM2-1903 | ¾ | 90 | 3 | | 535 | 6 |
| | | XWM2-1963 | ¾ | 96 | 3 | | 558 | 6 |
| | | XWM2-11023 | ¾ | 102 | 3 | | 581 | 6 |
| | | XWM2-11083 | ¾ | 108 | 3 | | 608 | 7 |
| | | XWM2-11143 | ¾ | 114 | 3 | | 630 | 7 |
| | | XWM2-11203 | ¾ | 120 | 3 | | 654 | 8 |
| | | XWM2-11263 | ¾ | 126 | 3 | | 677 | 8 |
| | | XWM2-11323 | ¾ | 132 | 3 | | 700 | 8 |
| | | XWM2-11383 | ¾ | 138 | 3 | | 720 | 9 |
| | | XWM2-11443 | ¾ | 144 | 3 | | 743 | 9 |

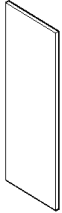
| Description | | Model Number | Depth | Width | Height | Notes | Price (US\$) | Weight (lbs.) |
|-------------|---|--------------|-------|-------|--------|-------|--------------|---------------|
| End Panel |  | XWE2-20127 | 20 | 1 1/4 | 27 1/4 | | 568 | 32 |
| | | XWE2-24127 | 24 | 1 1/4 | 27 1/4 | | 595 | 36 |
| | | XWE2-30127 | 30 | 1 1/4 | 27 1/4 | | 634 | 41 |
| | | XWE2-36127 | 36 | 1 1/4 | 27 1/4 | | 674 | 47 |
| | | XWE2-42127 | 42 | 1 1/4 | 27 1/4 | | 711 | 53 |
| | | XWE2-48127 | 48 | 1 1/4 | 27 1/4 | | 750 | 58 |
| | | XWE2-54127 | 54 | 1 1/4 | 27 1/4 | | 790 | 64 |
| | | XWE2-60127 | 60 | 1 1/4 | 27 1/4 | | 830 | 69 |
| | | XWE2-66127 | 66 | 1 1/4 | 27 1/4 | | 866 | 75 |
| | | XWE2-72127 | 72 | 1 1/4 | 27 1/4 | | 906 | 81 |
| | | XWE2-78127 | 78 | 1 1/4 | 27 1/4 | | 946 | 86 |
| | | XWE2-84127 | 84 | 1 1/4 | 27 1/4 | | 985 | 92 |
| | | XWE2-90127 | 90 | 1 1/4 | 27 1/4 | | 1022 | 97 |
| | | XWE2-96127 | 96 | 1 1/4 | 27 1/4 | | 1062 | 103 |
| End Panel |  | XWE2-20141 | 20 | 1 1/4 | 41 1/4 | | 818 | 48 |
| | | XWE2-24141 | 24 | 1 1/4 | 41 1/4 | | 854 | 54 |
| | | XWE2-30141 | 30 | 1 1/4 | 41 1/4 | | 911 | 63 |
| | | XWE2-36141 | 36 | 1 1/4 | 41 1/4 | | 967 | 71 |
| | | XWE2-42141 | 42 | 1 1/4 | 41 1/4 | | 1023 | 80 |
| | | XWE2-48141 | 48 | 1 1/4 | 41 1/4 | | 1080 | 88 |
| | | XWE2-54141 | 54 | 1 1/4 | 41 1/4 | | 1136 | 97 |
| | | XWE2-60141 | 60 | 1 1/4 | 41 1/4 | | 1192 | 105 |
| | | XWE2-66141 | 66 | 1 1/4 | 41 1/4 | | 1248 | 114 |
| | | XWE2-72141 | 72 | 1 1/4 | 41 1/4 | | 1305 | 122 |
| | | XWE2-78141 | 78 | 1 1/4 | 41 1/4 | | 1361 | 131 |
| | | XWE2-84141 | 84 | 1 1/4 | 41 1/4 | | 1417 | 140 |
| | | XWE2-90141 | 90 | 1 1/4 | 41 1/4 | | 1474 | 148 |
| | | XWE2-96141 | 96 | 1 1/4 | 41 1/4 | | 1530 | 157 |

| Description | | Model Number | Depth | Width | Height | Notes | Price (US\$) | Weight (lbs.) |
|-------------|---|--------------|-------|-------|--------|-------|--------------|---------------|
| End Panel |  | XWE2-15171 | 15 | 1 1/4 | 70 1/2 | | 954 | 71 |
| | | XWE2-20171 | 20 | 1 1/4 | 70 1/2 | | 1033 | 84 |
| | | XWE2-24171 | 24 | 1 1/4 | 70 1/2 | | 1093 | 94 |
| | | XWE2-30171 | 30 | 1 1/4 | 70 1/2 | | 1189 | 108 |
| | | XWE2-36171 | 36 | 1 1/4 | 70 1/2 | | 1282 | 123 |
| | | XWE2-42171 | 42 | 1 1/4 | 70 1/2 | | 1374 | 138 |
| | | XWE2-48171 | 48 | 1 1/4 | 70 1/2 | | 1470 | 153 |
| | | XWE2-54171 | 54 | 1 1/4 | 70 1/2 | | 1563 | 168 |
| | | XWE2-60171 | 60 | 1 1/4 | 70 1/2 | | 1656 | 182 |
| End Panel |  | XWE2-15183 | 15 | 1 1/4 | 82 1/2 | | 1027 | 84 |
| | | XWE2-20183 | 20 | 1 1/4 | 82 1/2 | | 1119 | 98 |
| | | XWE2-24183 | 24 | 1 1/4 | 82 1/2 | | 1189 | 101 |
| | | XWE2-30183 | 30 | 1 1/4 | 82 1/2 | | 1298 | 127 |
| | | XWE2-36183 | 36 | 1 1/4 | 82 1/2 | | 1407 | 144 |
| | | XWE2-42183 | 42 | 1 1/4 | 82 1/2 | | 1517 | 161 |
| | | XWE2-48183 | 48 | 1 1/4 | 82 1/2 | | 1626 | 179 |
| | | XWE2-54183 | 54 | 1 1/4 | 82 1/2 | | 1732 | 196 |
| | | XWE2-60183 | 60 | 1 1/4 | 82 1/2 | | 1841 | 213 |

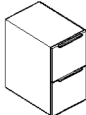
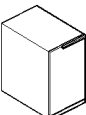
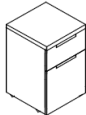
| Description | | Model Number | Depth | Width | Height | Notes | Price (US\$) | Weight (lbs.) |
|--|---|----------------|--------|--------|--------|------------------------------|--------------|---------------|
| Pedestal – Box / Box / File Drawers |  | XPA03-181628 | 18 3/8 | 15 3/4 | 27 3/4 | letter width | 1469 | 80 |
| | | XPA03-221628 | 22 3/8 | 15 3/4 | 27 3/4 | letter width | 1535 | 84 |
| | | XPA03-271628 | 27 3/8 | 15 3/4 | 27 3/4 | letter width | 1601 | 88 |
| | | XPC03-181928 | 18 3/8 | 18 3/4 | 27 3/4 | legal width | 1469 | 85 |
| | | XPC03-221928 | 22 3/8 | 18 3/4 | 27 3/4 | legal width | 1535 | 89 |
| | | XPC03-271928 | 27 3/8 | 18 3/4 | 27 3/4 | legal width | 1601 | 93 |
| includes lock top and back painted black | | | | | | | | |
| Pedestal – Two File Drawers |  | XPB03-181628 | 18 3/8 | 15 3/4 | 27 3/4 | letter width | 1469 | 78 |
| | | XPB03-221628 | 22 3/8 | 15 3/4 | 27 3/4 | letter width | 1535 | 82 |
| | | XPB03-271628 | 27 3/8 | 15 3/4 | 27 3/4 | letter width | 1601 | 84 |
| | | XPD03-181928 | 18 3/8 | 18 3/4 | 27 3/4 | legal width | 1469 | 83 |
| | | XPD03-221928 | 22 3/8 | 18 3/4 | 27 3/4 | legal width | 1535 | 87 |
| | | XPD03-271928 | 27 3/8 | 18 3/4 | 27 3/4 | legal width | 1601 | 91 |
| includes lock top and back painted black | | | | | | | | |
| Pedestal – Hinged Door Storage |  | XPH03-181628-L | 18 3/8 | 15 3/4 | 27 3/4 | letter width | 1102 | 35 |
| | | XPH03-221628-L | 22 3/8 | 15 3/4 | 27 3/4 | letter width | 1162 | 38 |
| | | XPH03-271628-L | 27 3/8 | 15 3/4 | 27 3/4 | letter width | 1251 | 41 |
| | | XPH03-181928-L | 18 3/8 | 18 3/4 | 27 3/4 | legal width | 1102 | 38 |
| | | XPH03-221928-L | 22 3/8 | 18 3/4 | 27 3/4 | legal width | 1162 | 41 |
| | | XPH03-271928-L | 27 3/8 | 18 3/4 | 27 3/4 | legal width | 1251 | 44 |
| specify L or R hinged door top and back painted black | | | | | | | | |
| Mobile Pedestal – One Box Drawer / One File Drawer |  | XPa05M-1816 | 18 3/8 | 15 3/4 | 21 1/4 | letter width | 1597 | 80 |
| | | XPa05M-2216 | 22 3/8 | 15 3/4 | 21 1/4 | legal width | 1663 | 84 |
| | | XPc05M-1819 | 18 3/8 | 18 3/4 | 27 3/4 | legal width | 1597 | 92 |
| | | XPc05M-2219 | 22 3/8 | 18 3/4 | 27 3/4 | legal width | 1663 | 96 |
| unit on casters + fifth wheel for dwr. stability fully finished 4 sides + top | | | | | | | | |
| Box Cushion for Mounting Atop Mobile Ped. | | XACUSH-18164 | 18 3/8 | 15 3/4 | 4 | requires one yard COM fabric | 262 | 2 |
| | | XACUSH-18194 | 18 3/8 | 18 3/4 | 4 | requires one yard COM fabric | 296 | 2 |

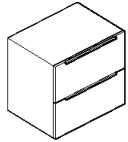
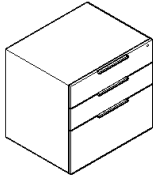
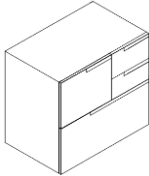
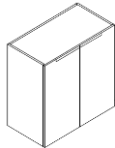
| Description | | Model Number | Depth | Width | Height | Notes | Price (US\$) | Weight (lbs.) |
|--|---|--------------|--------|-------|--------|-------|--------------|---------------|
| Pedestal – Lateral File |  | XPE03-183028 | 18 3/8 | 30 | 27 3/4 | | 1839 | 100 |
| | | XPE03-223028 | 22 3/8 | 30 | 27 3/4 | | 1895 | 108 |
| | | XPE03-273028 | 27 3/8 | 30 | 27 3/4 | | 1949 | 116 |
| | | XPF03-183628 | 18 3/8 | 36 | 27 3/4 | | 1839 | 110 |
| | | XPF03-223628 | 22 3/8 | 36 | 27 3/4 | | 1895 | 120 |
| | | XPF03-273628 | 27 3/8 | 36 | 27 3/4 | | 1949 | 130 |
| includes lock top and back painted black | | | | | | | | |
| Pedestal – Two Wide Box Dwr. /One Lateral File Dwr. |  | XPT03-183028 | 18 3/8 | 30 | 27 3/4 | | 1953 | 115 |
| | | XPT03-223028 | 22 3/8 | 30 | 27 3/4 | | 2038 | 123 |
| | | XPT03-273028 | 27 3/8 | 30 | 27 3/4 | | 2092 | 131 |
| | | XPU03-183628 | 18 3/8 | 36 | 27 3/4 | | 1953 | 121 |
| | | XPU03-223628 | 22 3/8 | 36 | 27 3/4 | | 2038 | 129 |
| | | XPU03-273628 | 27 3/8 | 36 | 27 3/4 | | 2092 | 137 |
| includes lock top and back painted black | | | | | | | | |
| Pedestal – Three Box Drawers Over One Lateral File Drawer |  | XPTX3-183028 | 18 3/8 | 30 | 27 3/4 | | 2441 | 100 |
| | | XPTX3-183028 | 22 3/8 | 30 | 27 3/4 | | 2525 | 112 |
| | | XPTX3-183028 | 27 3/8 | 30 | 27 3/4 | | 2580 | 124 |
| | | XPUX3-183628 | 18 3/8 | 36 | 27 3/4 | | 2441 | 118 |
| | | XPUX3-183628 | 22 3/8 | 36 | 27 3/4 | | 2525 | 130 |
| | | XPUX3-183628 | 27 3/8 | 36 | 27 3/4 | | 2580 | XXX |
| includes lock top and back painted black | | | | | | | | |
| Pedestal – Two Hinged Doors |  | XPHH3-183028 | 18 3/8 | 30 | 27 3/4 | | 1519 | 60 |
| | | XPHH3-223028 | 22 3/8 | 30 | 27 3/4 | | 1590 | 63 |
| | | XPHH3-273028 | 27 3/8 | 30 | 27 3/4 | | 1661 | 66 |
| | | XPHH3-183628 | 18 3/8 | 36 | 27 3/4 | | 1519 | 65 |
| | | XPHH3-223628 | 22 3/8 | 36 | 27 3/4 | | 1590 | 68 |
| | | XPHH3-273628 | 27 3/8 | 36 | 27 3/4 | | 1661 | 71 |
| one adj. shelf top and back painted black | | | | | | | | |

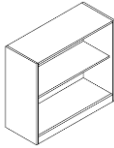
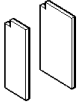
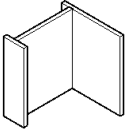
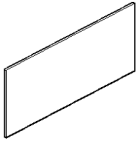
| Description | | Model Number | Depth | Width | Height | Notes | Price (US\$) | Weight (lbs.) |
|--|-----------|---------------|--------|--------|--------|-------|--------------|---------------|
| Pedestal – Bookshelf  one adj. shelf top and back painted black | | XPMM3-183028 | 18 3/8 | 30 | 27 3/4 | | 1255 | 50 |
| | | XPMM3-223028 | 22 3/8 | 30 | 27 3/4 | | 1314 | 53 |
| | | XPMM3-273028 | 27 3/8 | 30 | 27 3/4 | | 1374 | 56 |
| | | XPMM3-183628 | 18 3/8 | 36 | 27 3/4 | | 1255 | 54 |
| | | XPMM3-223628 | 22 3/8 | 36 | 27 3/4 | | 1314 | 58 |
| | | XPMM3-273628 | 27 3/8 | 36 | 27 3/4 | | 1374 | 62 |
| Bracing Leg  | | XWL2N0S-10128 | 10 | 1 1/4 | 27 3/4 | | 514 | 10 |
| | | XWL2N0S-15128 | 15 | 1 1/4 | 27 3/4 | | 541 | 15 |
| “L” End Panel  specify Left or Right | | XWE2-1816-R | 18 3/8 | 15 3/4 | 27 3/4 | | 562 | 31 |
| | | XWE2-2219-R | 22 3/8 | 18 3/4 | 27 3/4 | | 591 | 35 |
| | | XWE2-2719-R | 27 3/8 | 18 3/4 | 27 3/4 | | 625 | 40 |
| Tackboard  fabric covered standard w/ Gilford Anchorage 2335 COM price upon request tackboards are included when ordering Stanchion Mount Storage assemblies - see pgs. 31 - 34 | | XATBF-30 | 7/8 | 30 | 22 | | 188 | 17 |
| | | XATBF-36 | 7/8 | 36 | 22 | | 226 | 20 |
| | | XATBF-42 | 7/8 | 42 | 22 | | 262 | 23 |
| | | XATBF-48 | 7/8 | 48 | 22 | | 300 | 27 |
| | | XATBF-54 | 7/8 | 54 | 22 | | 338 | 30 |
| | | XATBF-60 | 7/8 | 60 | 22 | | 376 | 33 |
| | | XATBF-66 | 7/8 | 66 | 22 | | 411 | 37 |
| | | XATBF-72 | 7/8 | 72 | 22 | | 451 | 40 |
| | | XATBF-78 | 7/8 | 78 | 22 | | 489 | 43 |
| | | XATBF-84 | 7/8 | 84 | 22 | | 527 | 47 |
| | | XATBF-90 | 7/8 | 90 | 22 | | 561 | 50 |
| | | XATBF-96 | 7/8 | 96 | 22 | | 599 | 53 |
| | | XATBF-102 | 7/8 | 102 | 22 | | 639 | 57 |
| | | XATBF-108 | 7/8 | 108 | 22 | | 677 | 60 |
| | | XATBF-114 | 7/8 | 114 | 22 | | 712 | 63 |
| | | XATBF-120 | 7/8 | 120 | 22 | | 750 | 67 |
| | | XATBF-126 | 7/8 | 126 | 22 | | 789 | 70 |
| | XATBF-132 | 7/8 | 132 | 22 | | 827 | 73 | |
| | XATBF-138 | 7/8 | 138 | 22 | | 862 | 77 | |
| | XATBF-144 | 7/8 | 144 | 22 | | 900 | 80 | |

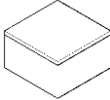
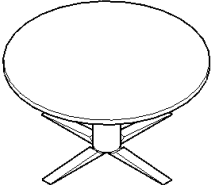
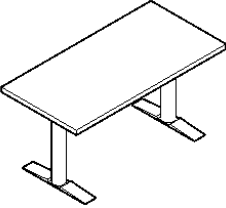
| Description | | Model Number | Depth | Width | Height | Notes | Price (US\$) | Weight (lbs.) |
|---|---|---------------|-------|-------|--------|----------------------|--------------|---------------|
| Occasional Drum Table |  | XTD-202018 | 20 | 20 | 18 | wood top | 1228 | 111 |
| | | XTD-262625 | 25½ | 25½ | 25 | wood top | 1624 | 138 |
| | | XTD-292925 | 29 | 29 | 25 | wood top | 2505 | 154 |
| | | XTD-292916 | 29 | 29 | 15½ | wood top | 2355 | 146 |
| glacier white Corain standard contact CCN for other colors | | XTD00S-202018 | 20 | 20 | 18 | ½ Corian overlay top | 1510 | 111 |
| | | XTD00S-262625 | 25½ | 25½ | 25 | ½ Corian overlay top | 1836 | 138 |
| | | XTD00S-292925 | 29 | 29 | 25 | ½ Corian overlay top | 2677 | 154 |
| | | XTD00S-292916 | 29 | 29 | 15½ | ½ Corian overlay top | 2527 | 146 |
| Occasional Cube Table |  | XTC-262625 | 26 | 26 | 25 | wood top | 1518 | 115 |
| | | XTC-203025 | 20 | 30 | 25 | wood top | 1475 | 106 |
| | | XTC-303025 | 30 | 30 | 25 | wood top | 1695 | 144 |
| | | XTC-292916 | 29 | 29 | 15½ | wood top | 1510 | 115 |
| glacier white Corain standard contact CCN for other colors | | XTC00S-262625 | 26 | 26 | 25 | ½ Corian overlay top | 1730 | 115 |
| | | XTC00S-203025 | 20 | 30 | 25 | ½ Corian overlay top | 1707 | 106 |
| | | XTC00S-303025 | 30 | 30 | 25 | ½ Corian overlay top | 1851 | 144 |
| | | XTC00S-292916 | 29 | 29 | 15½ | ½ Corian overlay top | 1682 | 115 |
| Circular Conference Table |  | XTR1X-3636 | 36 | 36 | 29¼ | wood top | 3517 | 95 |
| | | XTR1X-4242 | 42 | 42 | 29¼ | wood top | 4100 | 111 |
| | | XTR1X-4848 | 48 | 48 | 29¼ | wood top | 4908 | 130 |
| "X" base - chrome | | | | | | | | |
| Rectangular Conference Table w/ Legs |  | XTS2T-3060 | 30 | 60 | 29¼ | 2 bases | 3796 | 109 |
| | | XTS2T-3066 | 30 | 66 | 29¼ | 2 bases | 3946 | 115 |
| | | XTS2T-3072 | 30 | 72 | 29¼ | 2 bases | 4096 | 121 |
| | | XTS2T-3672 | 36 | 72 | 29¼ | 2 bases | 4352 | 164 |
| | | XTS2T-3666 | 36 | 66 | 29¼ | 2 bases | 4289 | 157 |
| | | XTS2T-3678 | 36 | 78 | 29¼ | 2 bases | 4516 | 172 |
| | | XTS3T-3684 | 36 | 84 | 29¼ | 3 bases | 5707 | 216 |
| | | XTS3T-4284 | 42 | 84 | 29¼ | 3 bases | 7351 | 243 |
| | | XTS3T-4290 | 42 | 90 | 29¼ | 3 bases | 7533 | 251 |
| | | XTS3T-4296 | 42 | 96 | 29¼ | 3 bases | 7716 | 260 |
| "T" bases - chrome | | | | | | | | |

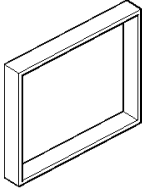
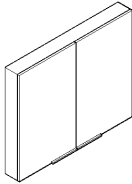
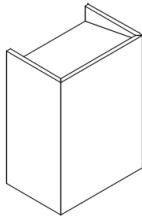
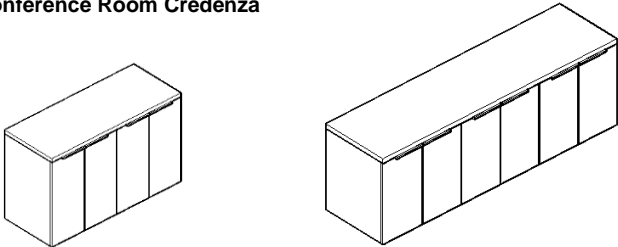
| Description | | Model Number | Depth | Width | Height | Notes | Price (US\$) | Weight (lbs.) |
|---|---|------------------|-------|-------|--------|-----------------------------|--------------|---------------|
| Presentation Board |  | XVBN-53648 | 4½ | 36 | 48 | | 948 | 6 |
| | | XVBN-54848 | 4½ | 48 | 48 | | 1105 | 8 |
| | | XVBN-56048 | 4½ | 60 | 48 | | 1509 | 9 |
| | | | | | | | | |
| dry erase board - white | | | | | | | | |
| Presentation Board w/ Hinged Doors |  | XVBH-63648 | 6 | 36 | 48 | | 1330 | 14 |
| | | XVBH-64848 | 6 | 48 | 48 | | 1594 | 18 |
| | | XVBH-66048 | 6 | 60 | 48 | | 2104 | 23 |
| | | | | | | | | |
| dry erase board - white | | | | | | | | |
| Podium |  | XVP-203042 | 20 | 30 | 42¼ | | 2455 | 117 |
| | | XVP-203642 | 20 | 36 | 42¼ | | 2734 | 129 |
| sloped top w/ laptop shelf | | | | | | | | |
| Conference Room Credenza |  | XC0V-2072-HHHH | 20 | 72 | 36 | two bay, four hinged doors | 4995 | 223 |
| | | XC0V-2084-HHHHHH | 20 | 84 | 36 | three bay, six hinged doors | 6276 | 260 |
| | | XC0V-2096-HHHHHH | 20 | 96 | 36 | three bay, six hinged doors | 6534 | 277 |
| | | XC0V-2472-HHHH | 24 | 72 | 36 | two bay, four hinged doors | 5210 | 233 |
| | | XC0V-2484-HHHHHH | 24 | 84 | 36 | three bay, six hinged doors | 6616 | 271 |
| | | XC0V-2496-HHHHHH | 24 | 96 | 36 | three bay, six hinged doors | 6881 | 290 |
| | | | | | | | | |

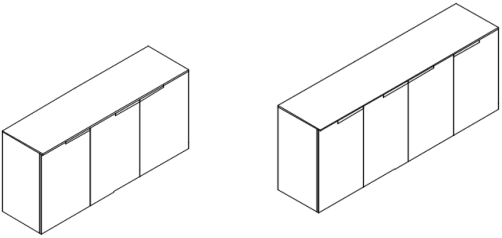
| Description | Model Number | Depth | Width | Height | Notes | Price (US\$) | Weight (lbs.) |
|--|-----------------|-------|-------|--------|-------------------------------|--------------|---------------|
| Conference Room Credenza  | XC0VS-2072-HHH | 20 | 72 | 36 | three bay, three hinged doors | 5648 | 223 |
| | XC0VS-2084-HHHH | 20 | 84 | 36 | four bay, four hinged doors | 6432 | 240 |
| | XC0VS-2096-HHHH | 20 | 96 | 36 | four bay, four hinged doors | 6712 | 257 |
| | XC0VS-2472-HHH | 24 | 72 | 36 | three bay, three hinged doors | 5893 | 233 |
| | XC0VS-2484-HHHH | 24 | 84 | 36 | four bay, four hinged doors | 6688 | 251 |
| | XC0VS-2496-HHHH | 24 | 96 | 36 | four bay, four hinged doors | 6984 | 270 |

½" overlay Corian top, glacier white standard
contact CCN for other colors

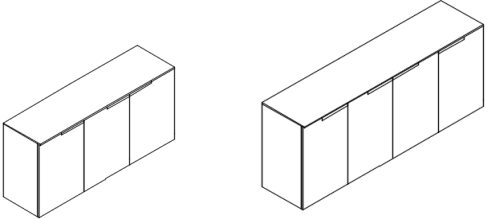
| | | | | | | | |
|--|---------------------|----|----|----|-------------------------------|------|-----|
| Conference Room Credenza  | XC0VS-2072-HHH-PTR | 20 | 72 | 36 | three bay, three hinged doors | 6748 | 248 |
| | XC0VS-2084-HHHH-PTR | 20 | 84 | 36 | four bay, four hinged doors | 7533 | 265 |
| | XC0VS-2096-HHHH-PTR | 20 | 96 | 36 | four bay, four hinged doors | 7812 | 282 |
| | XC0VS-2472-HHH-PTR | 24 | 72 | 36 | three bay, three hinged doors | 6993 | 258 |
| | XC0VS-2484-HHHH-PTR | 24 | 84 | 36 | four bay, four hinged doors | 7788 | 276 |
| | XC0VS-2496-HHHH-PTR | 24 | 96 | 36 | four bay, four hinged doors | 8085 | 295 |

pull out 2-bin trash/recycle
specify **L** or **R**
½" overlay Corian top, glacier white standard
contact CCN for other colors