

Edge Profiles

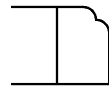

q



s

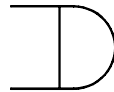

r

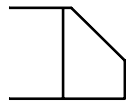

a

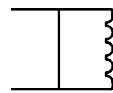

m

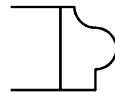

g

Hardware Styles



type 1
black, polished chrome
satin chrome



type 2
black
Polished brass

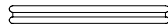

type 3
black
satin chrome

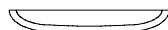

type 4
black, polished chrome
polished brass
satin chrome

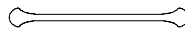

type 5
black, polished chrome
polished brass
satin chrome

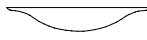

type 6
black,
polished chrome

FOUNDATION

Foundation products feature 1½" full overlay tops in any of six standard edge details. This detail is only present on seated and approach sides of desks and front sides of credenzas, returns, and bridges. Gallery workstations have no detail (worksurfaces are all square edged). Detail may be added to gallery workstations via the leading edge of transaction tops when they are specified. Conference tables feature detail on all sides and mitered corners.

The lower case prefix of a model number is used to indicate the edge profile desired. Detail profiles include: **a** (bevel), **g** (ogee), **m** (reeded), **q** (square), **r** (bullnose), and **s** (step radius). Many items in this pricelist already contain a lower case "x". This indicates an item with square detailing throughout and for which no other detail may be specified.

In addition, any of six hardware styles may be specified. These include: **1** a square section loop pull, **2** a semi-traditional loop pull, **3** a double ribbed loop pull, **4** a flat bar pull with radiused ends, **5** a tapered loop pull, and **6** a curvilinear pull.

In some cases (depending on the profile selected) a counter-profile detail will be employed where bridges or returns meet profiled edge worksurfaces. All other connections are via butt joints. Because there is no profile detail on the ends of credenzas or returns, all hi-rises are full dimension.

The backs of all storage units are "unfinished". This includes all hi-rises, tall storage, towers, anchors, spanner/wall cabinets, bookcases, pedestals, and lateral files. Unfinished backs will be either painted black or utilize a pre-finished black material.

An exit hole is provided in the backs of all hi-rises at valance height to accommodate task light wiring. As a result, tackboards are not required to conceal wiring. The backs of wall hung/spanner storage units are recessed ¾" to accommodate concealed wall hanging cleats.

Grommets are standard on all gallery workstation components, optional at an upcharge on all other items. Grommet locations are as follows: 24" deep credenzas - 3½" in from back and centered in kneespace, 20" deep credenzas - 3½" in and offset from center of kneespace (to allow for keyboard tray), bridges - 4" in and offset from center of kneespace, returns - 3½" in and offset from center of kneespace, corner bridges - centered in corner 6" in from each side, desks - 6" in from side (specify **Left** or **Right**) seated. Depth in from desk front varies depending on size of pedestal and front configuration (flush modesty, step modesty, bowfront).

CONFIGURATION EXAMPLES

Description

**Page
no.**

Model Number

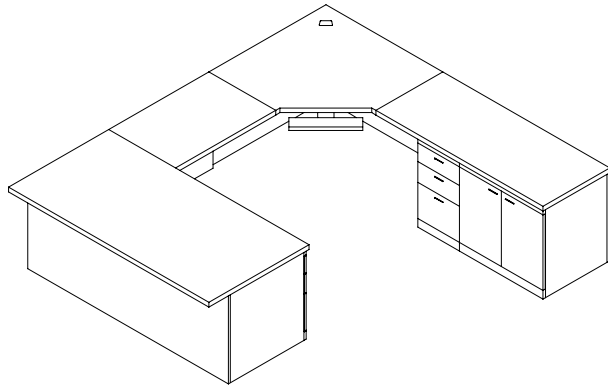

Configuration (edge profile **q** indicated)
overall dimension 102"D x 114"W x 29¼"H

Components:

Single Pedestal Desk	8	qD0-3672-CL
Bridge	15	qB000L-2436
Corner Bridge	16	qBC0-4242
Adjustable Keyboard Tray		AKTW-22
Large Black Grommet		AGR-BL
Return	18	qR000L-2460-CR
Additional HH Pedestal	85	xPHH3-2230

Configuration (edge profile **m** indicated)
overall dimension 72"D x 129"W x 70½"H

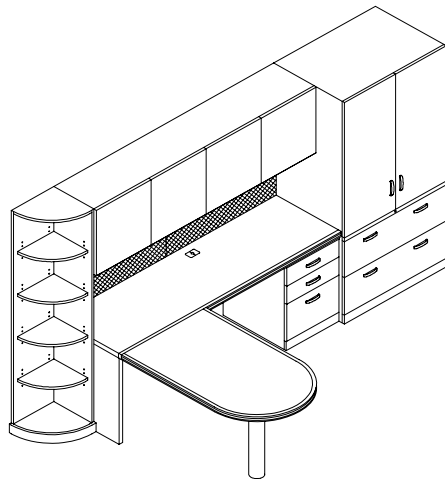

Components:

Single Pedestal Credenza	26	mC000K-2478-CR
Large Black Grommet		AGR- BL
Racetrack Runoff Desk	12	mDRUIN-3048
Hinged Door High-Rise Storage	36	xSUH20-1578
Tackboard		ATBF-78
Bend Shelving for High-Rise	52	xSE0140L-1515
Combination File/ Storage	58	xSSU122-253671

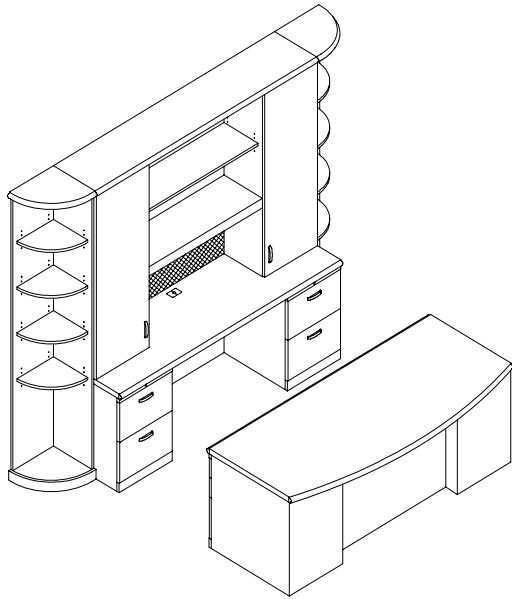

Configuration (edge profile **g** indicated)
overall dimension 108"W x 82½"H

Components:

Bow Top Double Pedestal Desk	10	g DB00S-3678-CD
Center Drawer		ACD-21
Bend Shelving for High Rise	52	xSE0150L-1515
Top Cap with Edge Profile	52	g WCF1A-1515
Double Pedestal Credenza	29	g C000L-2478-DKD
Large Black Grommet		AGR-BL
Split Storage Hi-Rise		xSUI332-157853
Tackboard		ATBF-42
Top Cap	61	g WCF1-1678
Bend Shelving for High Rise	52	xSE0150R-1515
Curved Overlay Top Detail	52	g WCF1A-1515

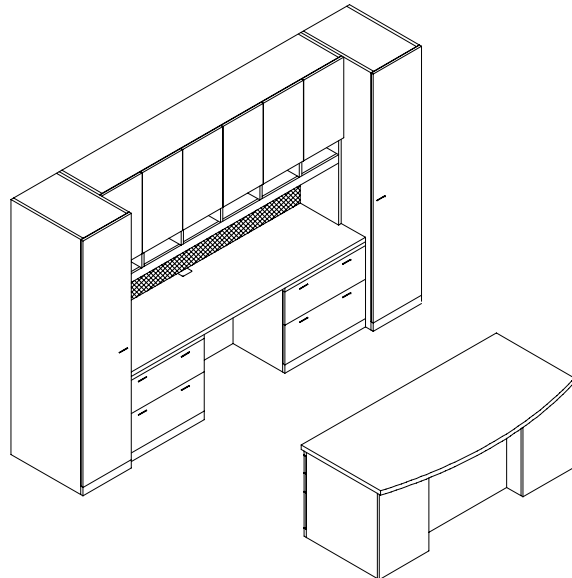

Configuration (edge profile **s** indicated)
overall dimension 122"W x 82½ "H

Components:

Bow Top Double Pedestal Desk	10	sDB00S-3678-CD
Hinged Door Storage w/ 5 Shelves	56	xSHU15-2516-L
Credenza w/ 2 Lateral Files	31	sC000L-2490-EKE
Large Black Grommet		AGR-BL
Hi-Rise w/ Doors & Organizer	40	xSUD31-1590
Tackboard		ATBF-90
Tasklights		ATL-48
Wardrobe	57	xSCU12- 2516-R

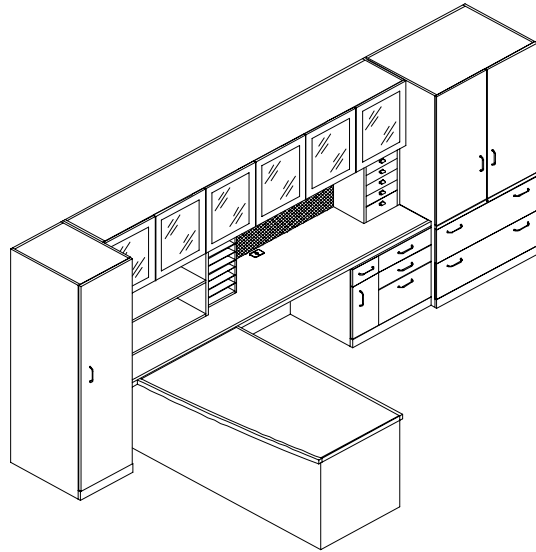

Configuration (edge profile **q** indicated)
overall dimension 84"D x 151"W x 70½"H

Components:

Hinged Door Storage	56	xSHU14-2519-L
Arc Front Runoff Desk with Single Pedestal	13	qDHU-3660-AL
Credenza with Single Pedestal	26	qC000L-2496-CR
Mini Pedestal-1 Box Drawer over Hinged Door		xPg03-249
Spanner Storage with Metal Framed Glass Doors	45	xSWH300A-1596
Bookcase		xSBU11-143620
Upper Storage Organizer Tackboard	51	xSPS-1211 ATBF-60
Upper Storage Organizer		xSPJ-1211
Combination File/Storage	58	xSSU122-2536

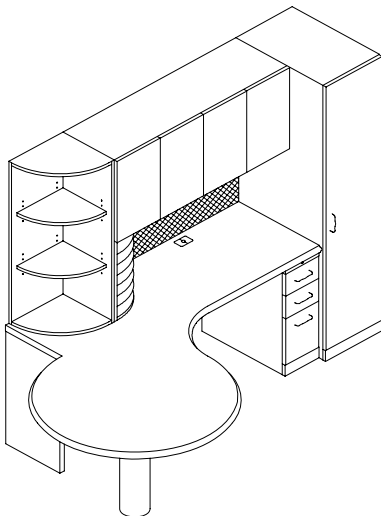

Configuration (edge profile **g** indicated)
overall dimension 57"D x 102¾"W x 70½"H

Components:

Eddy Runoff Worksurface w/ Grommet	89	gDEUH-5784-L-GL1
Keel	97	xWM2-1783
"L" Endpanel	87	xWE2-2210-L
Bend Shelving, Desktop	52	xSPE160-1212
Bend Shelving, High Rise	52	xSET120L-1414
Wall Mount/Spanner Storage w/ Doors Tackboard	44	xSWH21-1548 ATBF-48
Mini Pedestal- 2box, 1 File Drawers	83	xPa03-249
Wardrobe	57	xSCU11-2519-R

Configuration (edge profile **s** indicated)

Overall Dimensions: 132"D x 96"W x 29¼"H

Components:

Bend Worksurface	91	sWT11A-3030-L
Bend Pedestal with Shelves	86	xSEI110L-2929
Flow Worksurface - N with Grommet	93	sWT11N-3060-R-GL1
Lateral File Pedestal	85	xPF03-2236
Mini Pedestal - 2 box, 1 file	83	xPa03-249
Cove Corner Worksurface with Grommet	88	sBC0BTD-4242-0-GL1
Bracing Legs (2)	86	xWL2N0A-12
Eddy Runoff Worksurface with Grommet	89	sDEUH-5754-R-GL1
Perimeter Wall Mount Kit (14')	101	AMWB-168
Wall Mount End Cap	101	AMWB-CAP

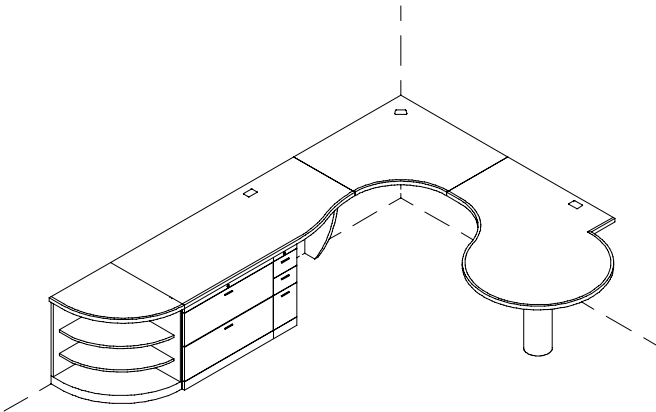

Configuration (edge profile **r** indicated)

Overall Dimensions: 72"D x 93"W x 53¼"H

Components:

Flow worksurface - M- w/ Grommet	92	rWT11M-3072-L-GL1
Keel	97	xWM2-1723
"L" End Panel	87	xWE2-2810
Droplet Runoff Worksurface	89	rDQUH-4242-L
Upper Storage Organizer (2)	51	xSPS-1216
Tackboard		ATBF-40
Sort Wing		xSPW5-12724
Pedestal - 2 Box, 1 File Drawers	84	xPA03-2216

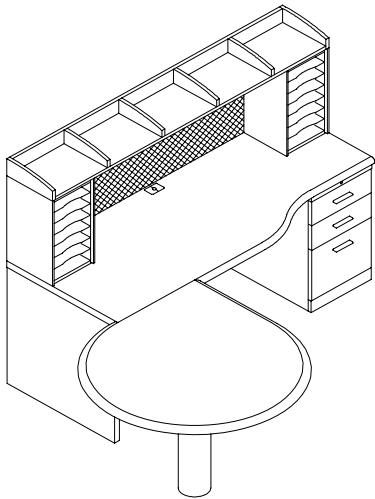

CONFIGURATION EXAMPLES

Description

Page
no.

Model Number

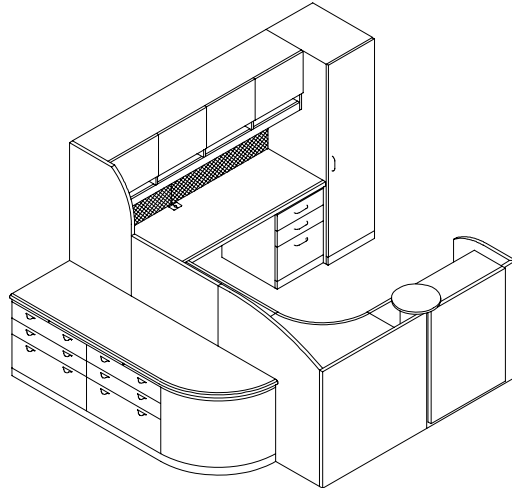

Configuration (edge profile **s** indicated)
 overall dimension 103"D x 112¼"W x 70½"H
 Components:

Wardrobe	57	xSCU11-2519-R
Workstation "L" End Panel w/ Arched Front	87	xWE20A-2517-L
Worksurface	94	q WT11S-2472
Large Black Grommet		AGR-BL
Pedestal	84	xPC03-2219
Spanner Storage w/ Doors & Organizer	48	xSWD20-1572
Tackboard		ATBF-72
Workstation Bridge with Grommet	75	S / B xBOR-2436-0-GL1
Workstation Corner Bridge w/ Arc Transition	77	xBCAB0D-4242-R-GL1
Gallery Return Shell w/ Arc Transition at end	77	xRAR-2436-L-GL1
Applied Anigre Feature Front		xSPIX-1271
Pedestal- Lateral File, 2 Box Drawers (2)		xPT03-2030
Bend-Pedestal-Curved Front		xSE000SR-1919
Bend Worksurface		sWT11A-2080

Organizer on Seated Side of Panel
 Mini Transaction Shelf

(note: Gallery Desk Worksurface
 are only available with square edge detail)

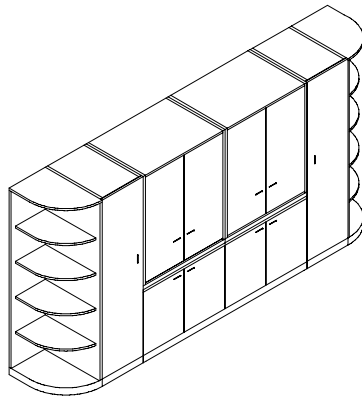

Configuration (edge profile **m** indicated)
 overall dimension 25"D x 140"W x 70½"H
 Components:

Bend Shelving	52	xSE0140L-2515
Hinged Door Storage	56	xSHU14-2519-L
Full Storage Credenza	22	m C000K-2072-HHHH
Upper Storage Video Cabinet (2)	55	xSUT10R-253641
With Full Height Retractable Doors		
Hinged Door Storage	56	xSHU14-251971-R
Bend Shelving	52	xSE0140R-2515

Shown with retractable doors closed

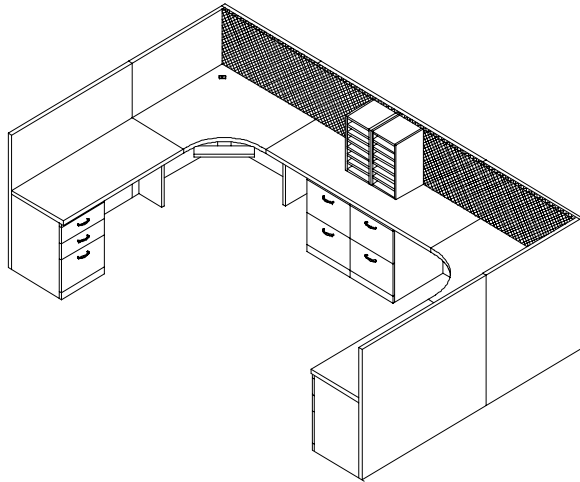

Configuration (edge profile **q** indicated)
overall dimension 72"D x 120"W x 50½"H

Components:

Workstation Return w/ Grommet	74	xR0R-243651-L-GL1
Pedestal - 2 Box, 1 File Drawers	84	xPC03-2219
Workstation Corner Bridge with Grommet	75	xBCRB0D-363651-0-GL1
Articulating Keyboard Tray		AKTW-22
Workstation Bridge with Grommet	75	xB0R-244851-0-GL1
Pedestal-2 File Drawers (2)	84	xPD03-2219
Upper Storage Organizer (2)	51	xSPS-1211
Workstation Corner Bridge with Grommet	75	xBCRB0D-363651-0-GL1
Articulating Keyboard Tray	65	AKTW-22
Workstation Return with Grommet	74	xR0R-243651-R-GL1
Pedestal-2 box, 1 File Drawer	84	xPC03-2219
Tackboard (2)		ATBF-42

(note: Workstation and Gallery Desk worksurfaces are only available with square edge detail.)

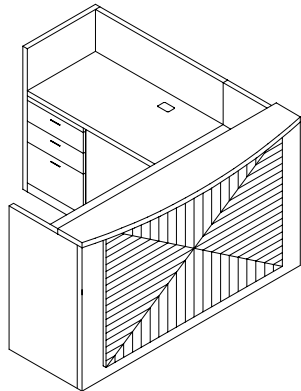

Configuration (edge profile **a** indicated)
overall dimension 72"D x 74½"W x 42¾"H

Components:

Gallery Desk w/ Single Pedestal	66	xD0R-2472-CR-GL2
Applied Feature Front #III - 58"w	72	1WFIII-15838
Bow Front Overlay Transaction Top	67	aWA11F-1472
Gallery Desk Return w/ Single Pedestal with Grommet	69	xR0R-2442-AL-GL1

(note: Workstations and Gallery Desk worksurfaces are only available with square edge detail. Detail may however be added to the transaction top leading visitor side edge)

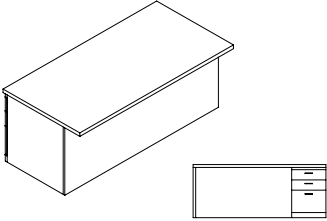
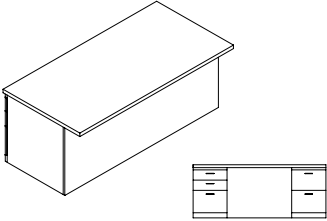
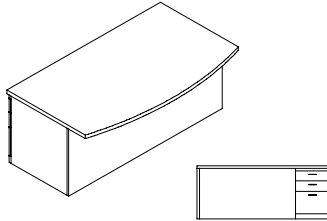
Description	Model Number	Overall Dimensions (in.)			Notes	
		Depth	Width	Height		
 <p>Single Pedestal Desk</p>	_D0-3066-AR	30	66	29¼	letter width b/b/f pedestal, 6" overhang	
	_D0-3072-CR	30	72	29¼	legal width b/b/f pedestal, 6" overhang	
	_D0-3078-CR	30	78	29¼	legal width b/b/f pedestal, 6" overhang	
	_D0-3084-CR	30	84	29¼	legal width b/b/f pedestal, 6" overhang	
	_D0-3672-CR	36	72	29¼	legal width b/b/f pedestal, 6¾" overhang	
	_D0-3678-CR	36	78	29¼	legal width b/b/f pedestal, 6¾" overhang	
	_D0-3684-CR	36	84	29¼	legal width b/b/f pedestal, 6¾" overhang	
	Straight front full overhang Specify Left or Right (seated) (Right indicated)					
	 <p>Double Pedestal Desk</p>	_D0-3066-AB	30	66	29¼	letter width b/b/f & f/f pedestals, 6" overhang
_D0-3072-CD		30	72	29¼	legal width b/b/f & f/f pedestals, 6" overhang	
_D0-3078-CD		30	78	29¼	legal width b/b/f & f/f pedestals, 6" overhang	
_D0-3084-CD		30	84	29¼	legal width b/b/f & f/f pedestals, 6" overhang	
_D0-3672-CD		36	72	29¼	legal width b/b/f & f/f pedestals, 6¾" overhang	
_D0-3678-CD		36	78	29¼	legal width b/b/f & f/f pedestals, 6¾" overhang	
_D0-3684-CD		36	84	29¼	legal width b/b/f & f/f pedestals, 6¾" overhang	
Straight front full overhang						
 <p>Bow Top Single Pedestal Desk</p>		_DB-3666-AR	30/36	66	29¼	letter width b/b/f pedestal, 12" overhang
	_DB-3672-CR	30/36	72	29¼	legal width b/b/f pedestal, 12" overhang	
	_DB-3678-CR	30/36	78	29¼	legal width b/b/f pedestal, 12" overhang	
	_DB-3684-CR	30/36	84	29¼	legal width b/b/f pedestal, 12" overhang	
	_DB-4272-CR	36/42	72	29¼	legal width b/b/f pedestal, 12¾" overhang	
	_DB-4278-CR	36/42	78	29¼	legal width b/b/f pedestal, 12¾" overhang	
	_DB-4284-CR	36/42	84	29¼	legal width b/b/f pedestal, 12¾" overhang	
	Straight front full overhang Specify Left or Right (seated) (Right indicated)					

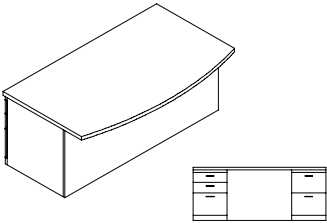
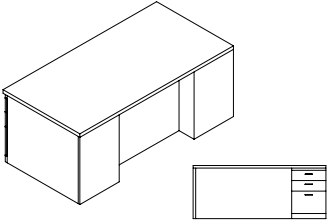
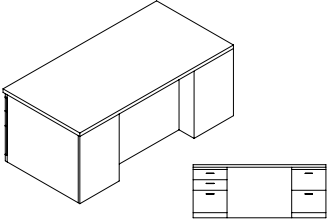
Description	Model Number	Overall Dimensions (in.)			Notes
		Depth	Width	Height	
	_DB-3666-AB	30/36	66	29¼	letter width b/b/f & f/f pedestals, 12" overhang
	_DB-3672-CD	30/36	72	29¼	legal width b/b/f & f/f pedestals, 12" overhang
	_DB-3678-CD	30/36	78	29¼	legal width b/b/f & f/f pedestals, 12" overhang
	_DB-3684-CD	30/36	84	29¼	legal width b/b/f & f/f pedestals, 12" overhang
	_DB-4272-CD	36/42	72	29¼	legal width b/b/f & f/f pedestals, 12¾" overhang
	_DB-4278-CD	36/42	78	29¼	legal width b/b/f & f/f pedestals, 12¾" overhang
	_DB-4284-CD	36/42	84	29¼	legal width b/b/f & f/f pedestals, 12¾" overhang
	Straight front full overhang				
	_D000S-3066-AR	30	66	29¼	letter width b/b/f pedestal
	_D000S-3072-CR	30	72	29¼	legal width b/b/f pedestal
	_D000S-3078-CR	30	78	29¼	legal width b/b/f pedestal
	_D000S-3084-CR	30	84	29¼	legal width b/b/f pedestal
	_D000S-3672-CR	36	72	29¼	legal width b/b/f pedestal
	_D000S-3678-CR	36	78	29¼	legal width b/b/f pedestal
	_D000S-3684-CR	36	84	29¼	legal width b/b/f pedestal
Recessed center modesty panel Specify Left or Right (seated) (Right indicated)					
	_D000S-3066-AB	30	66	29¼	letter width b/b/f & f/f pedestals
	_D000S-3072-CD	30	72	29¼	legal width b/b/f & f/f pedestals
	_D000S-3078-CD	30	78	29¼	legal width b/b/f & f/f pedestals
	_D000S-3084-CD	30	84	29¼	legal width b/b/f & f/f pedestals
	_D000S-3672-CD	36	72	29¼	legal width b/b/f & f/f pedestals
	_D000S-3678-CD	36	78	29¼	legal width b/b/f & f/f pedestals
	_D000S-3684-CD	36	84	29¼	legal width b/b/f & f/f pedestals
Recessed center modesty panel					

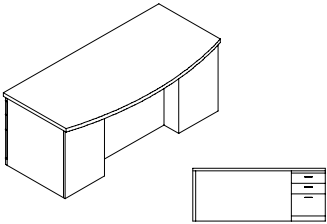
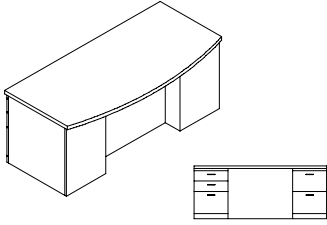
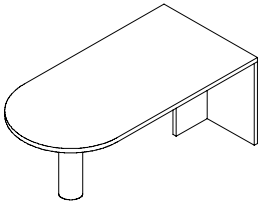
Description	Model Number	Overall Dimensions (in.)			Notes	
		Depth	Width	Height		
Bow Top Single Pedestal Desk 	_DB00S-3666-AR	30/36	66	29¼	letter width b/b/f pedestal, 6" overhang	
	_DB00S-3672-CR	30/36	72	29¼	legal width b/b/f pedestal, 6" overhang	
	_DB00S-3678-CR	30/36	78	29¼	legal width b/b/f pedestal, 6" overhang	
	_DB00S-3684-CR	30/36	84	29¼	legal width b/b/f pedestal, 6" overhang	
	_DB00S-4272-CR	36/42	72	29¼	legal width b/b/f pedestal, 6" overhang	
	_DB00S-4278-CR	36/42	78	29¼	legal width b/b/f pedestal, 6" overhang	
	_DB00S-4284-CR	36/42	84	29¼	legal width b/b/f pedestal, 6" overhang	
Recessed center modesty Specify Left or Right (seated)	(Right indicated)					
Bow Top Double Pedestal Desk 	_DB00S-3666-AB	30/36	66	29¼	letter width b/b/f & f/f pedestals, 6" overhang	
	_DB00S-3672-CD	30/36	72	29¼	legal width b/b/f & f/f pedestals, 6" overhang	
	_DB00S-3678-CD	30/36	78	29¼	legal width b/b/f & f/f pedestals, 6" overhang	
	_DB00S-3684-CD	30/36	84	29¼	legal width b/b/f & f/f pedestals, 6" overhang	
	_DB00S-4272-CD	36/42	72	29¼	legal width b/b/f & f/f pedestals, 6" overhang	
	_DB00S-4278-CD	36/42	78	29¼	legal width b/b/f & f/f pedestals, 6" overhang	
	_DB00S-4284-CD	36/42	84	29¼	legal width b/b/f & f/f pedestals, 6" overhang	
Recessed center modesty						
Peninsula Desk 	_DR0IN-3066	30	66	29¼		
	_DR0IN-3072	30	72	29¼		
	_DR0IN-3078	30	78	29¼		
	_DR0IN-3084	30	84	29¼		
	_DR0IN-3090	30	90	29¼		
	_DR0IN-3096	30	96	29¼		
	_DR0IN-3666	36	66	29¼		
	_DR0IN-3672	36	72	29¼		
	_DR0IN-3678	36	78	29¼		
	_DR0IN-3684	36	84	29¼		
	With "T" end panel and 4" post leg	_DR0IN-3690	36	90	29¼	
	Specify chrome or black leg	_DR0IN-3696	36	96	29¼	

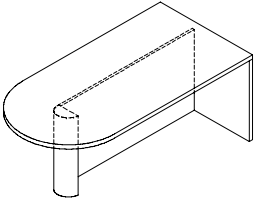
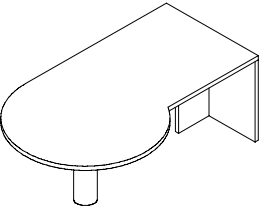
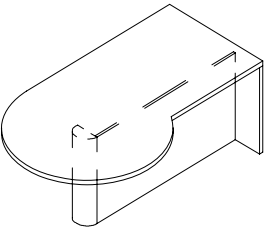
Description	Model Number	Overall Dimensions (in.)			Notes
		Depth	Width	Height	
Peninsula Desk 	_DR0UL-3066- R	30	66	29¼	
	_DR0UL-3072- R	30	72	29¼	
	_DR0UL-3078- R	30	78	29¼	
	_DR0UL-3084- R	30	84	29¼	
	_DR0UL-3090- R	30	90	29¼	
	_DR0UL-3096- R	30	96	29¼	
	_DR0UL-3666- R	36	66	29¼	
	_DR0UL-3672- R	36	72	29¼	
	_DR0UL-3678- R	36	78	29¼	
	With end panel, full modesty and 16" split drum leg Specify Left or Right	_DR0UL-3684- R	36	84	29¼
	_DR0UL-3690- R	36	90	29¼	
	_DR0UL-3696- R	36	96	29¼	
"P" Top Peninsula Desk 	_DP0HN-4272- R	30/42	72	29¼	
	_DP0HN-4278- R	30/42	78	29¼	
	_DP0HN-4284- R	30/42	84	29¼	
	_DP0HN-4290- R	30/42	90	29¼	
	_DP0HN-4296- R	30/42	96	29¼	
	_DP0HN-4878- R	36/48	78	29¼	
	_DP0HN-4884- R	36/48	84	29¼	
	_DP0HN-4890- R	36/48	90	29¼	
	_DP0HN-4896- R	36/48	96	29¼	
	With "T" end panel, and 6" post leg Specify chrome or black leg Specify Left or Right (seated)				
"P" Top Peninsula Desk 	_DP0UL-4272- R	30/42	72	29¼	
	_DP0UL-4278- R	30/42	78	29¼	
	_DP0UL-4284- R	30/42	84	29¼	
	_DP0UL-4290- R	30/42	90	29¼	
	_DP0UL-4296- R	30/42	96	29¼	
	_DP0UL-4878- R	36/48	72	29¼	
	_DP0UL-4878- R	36/48	78	29¼	
	_DP0UL-4884- R	36/48	84	29¼	
	_DP0UL-4890- R	36/48	90	29¼	
	_DP0UL-4896- R	36/48	96	29¼	
With end panel, full modesty and 16" split drum leg Specify Left or Right (seated)					
	(Right indicated)				

(unless otherwise specified, conferencing radius is on approach side of configuration)

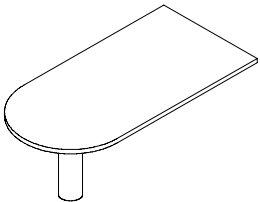
Description	Model Number	Overall Dimensions (in.)			Notes
		Depth	Width	Height	
	_DRUIN-3048	30	48	29¼	
	_DRUIN-3054	30	54	29¼	
	_DRUIN-3060	30	60	29¼	
	_DRUIN-3066	30	66	29¼	
	_DRUIN-3072	30	72	29¼	
	_DRUIN-3648	36	48	29¼	
	_DRUIN-3654	36	54	29¼	
	_DRUIN-3660	36	60	29¼	
	_DRUIN-3666	36	66	29¼	
	_DRUIN-3672	36	72	29¼	

4" post leg
Specify chrome or black leg

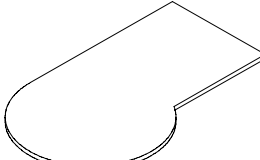
	_DPUHN-4266-R	30/42	66	29¼	
	_DPUHN-4272-R	30/42	72	29¼	
	_DPUHN-4278-R	30/42	78	29¼	
	_DPUHN-4866-R	36/48	66	29¼	
	_DPUHN-4872-R	36/48	72	29¼	
	_DPUHN-4878-R	36/48	78	29¼	

6" post leg
Specify chrome or black leg
Specify Left or Right

(Right indicated)

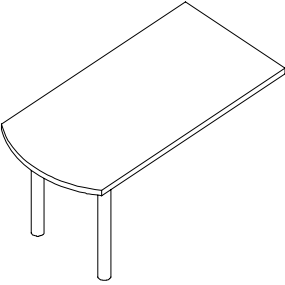
	_DWUIN-3048	30	48	29¼	
	_DWUIN-3054	30	54	29¼	
	_DWUIN-3060	30	60	29¼	
	_DWUIN-3066	30	66	29¼	
	_DWUIN-3072	30	72	29¼	
	_DWUIN-3648	36	48	29¼	
	_DWUIN-3654	36	54	29¼	
	_DWUIN-3660	36	60	29¼	
	_DWUIN-3666	36	66	29¼	
	_DWUIN-3672	36	72	29¼	

2 - 4" post legs
Specify chrome or black leg

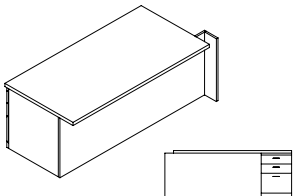
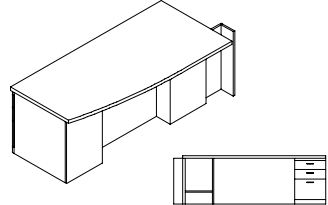
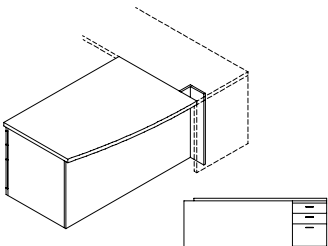
Description	Model Number	Overall Dimensions (in.)			Notes	
		Depth	Width	Height		
Runoff Desk 	_DU00L-3054-CR	30	54	29¼	legal width b/b/f pedestal	
	_DU00L-3060-CR	30	60	29¼	legal width b/b/f pedestal	
	_DU00L-3066-CR	30	66	29¼	legal width b/b/f pedestal	
	_DU00L-3072-CR	30	72	29¼	legal width b/b/f pedestal	
	_DU00L-3654-CR	36	54	29¼	legal width b/b/f pedestal	
	_DU00L-3660-CR	36	60	29¼	legal width b/b/f pedestal	
	_DU00L-3666-CR	36	66	29¼	legal width b/b/f pedestal	
	_DU00L-3672-CR	36	72	29¼	legal width b/b/f pedestal	
	Specify Left or Right (seated)	(Right indicated)				
	Arc Front Runoff Desk with Single Pedestal 	_DH00S-3672-CR	30/36	72	29¼	legal width b/b/f pedestal
_DH00S-3678-CR		30/36	78	29¼	legal width b/b/f pedestal	
_DH00S-3684-CR		30/36	84	29¼	legal width b/b/f pedestal	
_DH00S-3690-CR		30/36	90	29¼	legal width b/b/f pedestal	
Specify Left or Right (seated)		(Right indicated)				
Recessed center modesty panel Specify Left or Right (seated)						
	Arc Front Runoff Desk with Single Pedestal 	_DHU-3654-AR	30/36	54	29¼	letter width b/b/f pedestal
		_DHU-3660-AR	30/36	60	29¼	letter width b/b/f pedestal
		_DHU-3666-AR	30/36	66	29¼	letter width b/b/f pedestal
Specify Left or Right (seated)	(Right indicated)					

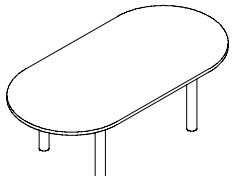
Description	Model Number	Overall Dimensions (in.)			Notes
		Depth	Width	Height	
	_TR4I-3060	30	60	29¼	
	_TR4I-3066	30	66	29¼	
	_TR4I-3072	30	72	29¼	
	_TR4I-3666	36	66	29¼	
	_TR4I-3672	36	72	29¼	
	_TR4I-3678	36	78	29¼	
	_TR4I-3684	36	84	29¼	
	_TR4I-4284	42	84	29¼	

4- 4" post legs
Specify chrome or black legs

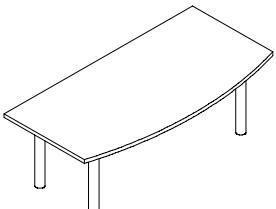
	_TF4I-3666	30/36	66	29¼	
	_TF4I-3672	30/36	72	29¼	
	_TF4I-3678	30/36	78	29¼	
	_TF4I-3684	30/36	84	29¼	
	_TF4I-4266	36/42	66	29¼	
	_TF4I-4272	36/42	72	29¼	
	_TF4I-4278	36/42	78	29¼	
	_TF4I-4284	36/42	84	29¼	

4- 4" post legs
Specify chrome or black legs

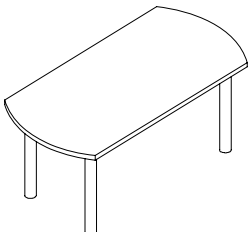
	_TW4I-3672	36	72	29¼	
	_TW4I-3678	36	78	29¼	
	_TW4I-3684	36	84	29¼	

4- 4" post legs
Specify chrome or black legs

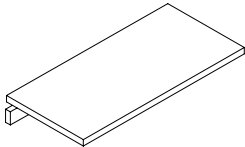
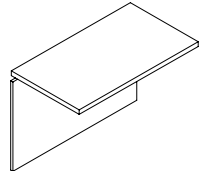
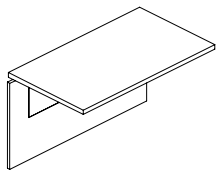
Description	Model Number	Overall Dimensions (in.)			Notes	
		Depth	Width	Height		
	_B000K-2030	20	30	29¼		
	_B000K-2036	20	36	29¼		
	_B000K-2042	20	42	29¼		
	_B000K-2048	20	48	29¼		
	_B000K-2054	20	54	29¼		
	_B000K-2060	20	60	29¼		
	_B000K-2430	24	30	29¼		
	_B000K-2436	24	36	29¼		
	_B000K-2442	24	42	29¼		
	_B000K-2448	24	48	29¼		
	_B000K-2454	24	54	29¼		
	Open back with solid wood keel	_B000K-2460	24	60	29¼	
		_B000L-2030	20	30	29¼	
		_B000L-2036	20	36	29¼	
_B000L-2042		20	42	29¼		
_B000L-2048		20	48	29¼		
_B000L-2054		20	54	29¼		
_R000L-2060		20	60	29¼		
_B000L-2430		24	30	29¼		
_B000L-2436		24	36	29¼		
_B000L-2442		24	42	29¼		
_B000L-2448		24	48	29¼		
_B000L-2454		24	54	29¼		
Full finished modesty panel		_B000L-2460	24	60	29¼	
		_B000H-2030	20	30	29¼	
		_B000H-2036	20	36	29¼	
	_B000H-2042	20	42	29¼		
	_B000H-2048	20	48	29¼		
	_B000H-2054	20	54	29¼		
	_B000H-2060	20	60	29¼		
	_B000H-2430	24	30	29¼		
	_B000H-2436	24	36	29¼		
	_B000H-2442	24	42	29¼		
	_B000H-2448	24	48	29¼		
	_B000H-2454	24	54	29¼		
	Hinged modesty panel	_B000H-2460	24	60	29¼	

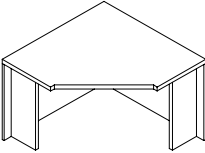
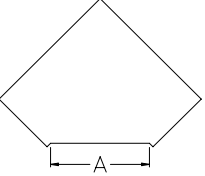
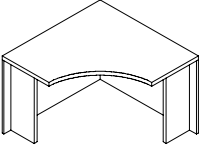
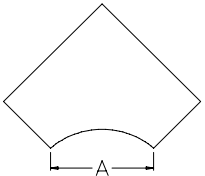
Description	Model Number	Overall Dimensions (in.)			Notes
		Depth	Width	Height	
Corner Bridge	_BC0-3636	36	36	29¼	connects to 20" units each side "A" = 19"
 	_BC0-4242	42	42	29¼	connects to 20" or 24" units* 20" units each side "A" = 27⅞" 24" unit on one side and 20" or 24" unit on other side "A" = 21¾"
Seated Diagonal Full finished modesty panels					
Corner Bridge	_BC000D-3636	36	36	29¼	connects to 20" units each side "A" = 22⅝"
 	_BC000D-4242	42	42	29¼	connects to 20" or 24" units* 20" units each side "A" = 31⅛ " 24" units one side and 20" or 24" unit on other side "A" = 25½"
* Depth of connecting units will determine actual top size. Corner bridge may be longer and adjacent unit shorter to maintain a 45 front edge. The adjustment will be made at the factory and will not affect the overall configured size.					
Seated Radius Full finished modesty panels					

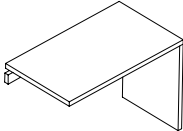
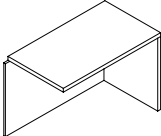
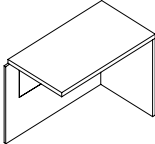
Description	Model Number	Overall Dimensions (in.)			Notes	
		Depth	Width	Height		
	_R000K-2030- R	20	30	29¼		
	_R000K-2036- R	20	36	29¼		
	_R000K-2042- R	20	42	29¼		
	_R000K-2048- R	20	48	29¼		
	_R000K-2054- R	20	54	29¼		
	_R000K-2060- R	20	60	29¼		
	_R000K-2430- R	24	30	29¼		
	_R000K-2436- R	24	36	29¼		
	_R000K-2442- R	24	42	29¼		
	_R000K-2448- R	24	48	29¼		
	Open back with solid wood keel	_R000K-2454- R	24	54	29¼	
	Specify L or R (Right indicated)	_R000K-2460- R	24	60	29¼	
		_R000L-2030- R	20	30	29¼	
		_R000L-2036- R	20	36	29¼	
_R000L-2042- R		20	42	29¼		
_R000L-2048- R		20	48	29¼		
_R000L-2054- R		20	54	29¼		
_R000L-2060- R		20	60	29¼		
_R000L-2430- R		24	30	29¼		
_R000L-2436- R		24	36	29¼		
_R000L-2442- R		24	42	29¼		
_R000L-2448- R		24	48	29¼		
Full finished modesty panel		_R000L-2454- R	24	54	29¼	
Specify L or R (Right indicated)		_R000L-2460- R	24	60	29¼	
		_R000H-2030- R	20	30	29¼	
		_R000H-2036- R	20	36	29¼	
	_R000H-2042- R	20	42	29¼		
	_R000H-2048- R	20	48	29¼		
	_R000H-2054- R	20	54	29¼		
	_R000H-2060- R	20	60	29¼		
	_R000H-2430- R	24	30	29¼		
	_R000H-2436- R	24	36	29¼		
	_R000H-2442- R	24	42	29¼		
	_R000H-2448- R	24	48	29¼		
	Full finished modesty panel	_R000H-2454- R	24	54	29¼	
	Specify L or R (Right Indicated)	_R000H-2460- R	24	60	29¼	

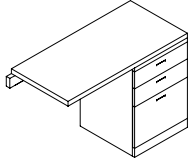
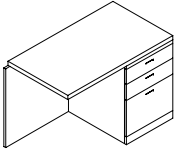
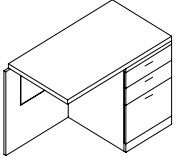
Description	Model Number	Overall Dimensions (in.)			Notes
		Depth	Width	Height	
	Return	_R000K-2030-CR	20	30	29¼
		_R000K-2036-CR	20	36	29¼
		_R000K-2042-CR	20	42	29¼
		_R000K-2048-CR	20	48	29¼
		_R000K-2054-CR	20	54	29¼
		_R000K-2060-CR	20	60	29¼
		_R000K-2430-CR	24	30	29¼
		_R000K-2436-CR	24	36	29¼
		_R000K-2442-CR	24	42	29¼
		_R000K-2448-CR	24	48	29¼
Open back with keel		_R000K-2454-CR	24	54	29¼
Legal width b/b/f pedestal		_R000K-2460-CR	24	60	29¼
Specify L or R (Right indicated)					
	Return	_R000L-2030-CR	20	30	29¼
		_R000L-2036-CR	20	36	29¼
		_R000L-2042-CR	20	42	29¼
		_R000L-2048-CR	20	48	29¼
		_R000L-2054-CR	20	54	29¼
		_R000L-2060-CR	20	60	29¼
		_R000L-2430-CR	24	30	29¼
		_R000L-2436-CR	24	36	29¼
		_R000L-2442-CR	24	42	29¼
		_R000L-2448-CR	24	48	29¼
Full finished modesty panel		_R000L-2454-CR	24	54	29¼
Legal width b/b/f pedestal		_R000L-2460-CR	24	60	29¼
Specify L or R (Right indicated)					
	Return	_R000H-2030-CR	20	30	29¼
		_R000H-2036-CR	20	36	29¼
		_R000H-2042-CR	20	42	29¼
		_R000H-2048-CR	20	48	29¼
		_R000H-2054-CR	20	54	29¼
		_R000H-2060-CR	20	60	29¼
		_R000H-2430-CR	24	30	29¼
		_R000H-2436-CR	24	36	29¼
		_R000H-2442-CR	24	42	29¼
		_R000H-2448-CR	24	48	29¼
Hinged modesty panel		_R000H-2454-CR	24	54	29¼
Legal width b/b/f pedestal		_R000H-2460-CR	24	60	29¼
Specify L or R (Right indicated)					

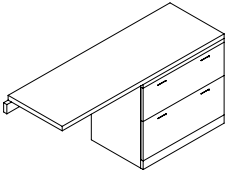
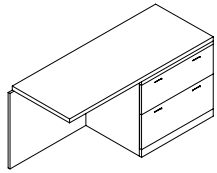
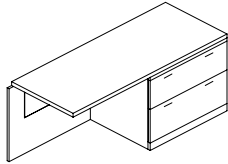
Description	Model Number	Overall Dimensions (in.)			Notes
		Depth	Width	Height	
	Return	_R000K-2048-ER	20	48	29¼
		_R000K-2054-ER	20	54	29¼
		_R000K-2060-ER	20	60	29¼
		_R000K-2066-ER	20	66	29¼
		_R000K-2072-ER	20	72	29¼
		_R000K-2448-ER	24	48	29¼
		_R000K-2454-ER	24	54	29¼
		_R000K-2460-ER	24	60	29¼
	Open back with solid wood keel	_R000K-2466-ER	24	66	29¼
	30" w lateral file pedestal	_R000K-2472-ER	24	72	29¼
Specify L or R	(R ight indicated)				
	Return	_R000L-2048-ER	20	48	29¼
		_R000L-2054-ER	20	54	29¼
		_R000L-2060-ER	20	60	29¼
		_R000L-2066-ER	20	66	29¼
		_R000L-2072-ER	20	72	29¼
		_R000L-2448-ER	24	48	29¼
		_R000L-2454-ER	24	54	29¼
		_R000L-2460-ER	24	60	29¼
	Full finished modesty panel	_R000L-2466-ER	24	66	29¼
	30" w lateral file pedestal	_R000L-2472-ER	24	72	29¼
Specify L or R	(R ight indicated)				
	Return	_R000H-2048-ER	20	48	29¼
		_R000H-2054-ER	20	54	29¼
		_R000H-2060-ER	20	60	29¼
		_R000H-2066-ER	20	66	29¼
		_R000H-2072-ER	20	72	29¼
		_R000H-2448-ER	24	48	29¼
		_R000H-2454-ER	24	54	29¼
		_R000H-2460-ER	24	60	29¼
	Full finished modesty panel	_R000H-2466-ER	24	66	29¼
	30" w lateral file pedestal	_R000H-2472-ER	24	72	29¼
Specify L or R	(R ight indicated)				

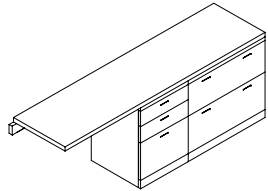
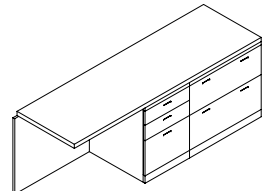
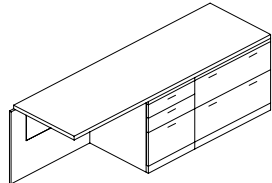
Description	Model Number	Overall Dimensions (in.)			Notes	
		Depth	Width	Height		
	Return	_R000K-2078-CER	20	78	29¼	
		_R000K-2084-CER	20	84	29¼	
		_R000K-2090-CER	20	90	29¼	
		_R000K-2096-CER	20	96	29¼	
		_R000K-2478-CER	24	78	29¼	
		_R000K-2484-CER	24	84	29¼	
		_R000K-2490-CER	24	90	29¼	
		_R000K-2496-CER	24	96	29¼	
	Open back with keel 30" w lateral file & legal width b/b/f pedestal Specify Left or Right (seated) (Right indicated)					
		Return	_R000L-2078-CER	20	78	29¼
		_R000L-2084-CER	20	84	29¼	
		_R000L-2090-CER	20	90	29¼	
		_R000L-2096-CER	20	96	29¼	
		_R000L-2478-CER	24	78	29¼	
		_R000L-2484-CER	24	84	29¼	
		_R000L-2490-CER	24	90	29¼	
		_R000L-2496-CER	24	96	29¼	
Full finished modesty panel 30" w lateral file & legal width b/b/f pedestal Specify Left or Right (seated) (Right indicated)						
		Return	_R000H-2078-CER	20	78	29¼
		_R000H-2084-CER	20	84	29¼	
		_R000H-2090-CER	20	90	29¼	
		_R000H-2096-CER	20	96	29¼	
		_R000H-2478-CER	24	78	29¼	
		_R000H-2484-CER	24	84	29¼	
		_R000H-2490-CER	24	90	29¼	
		_R000H-2496-CER	24	96	29¼	
	Hinged modesty panel 30" w lateral file & legal width b/b/f pedestal Specify Left or Right (seated) (Right indicated)					

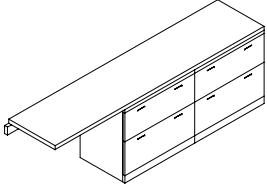
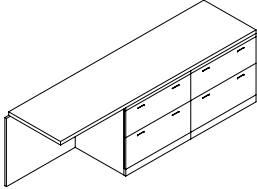
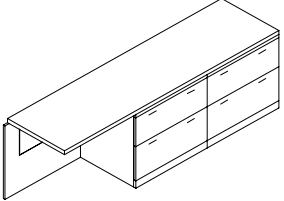
Description	Model Number	Overall Dimensions (in.)			Notes
		Depth	Width	Height	
<p>Return</p>  <p>Open back with keel 2-30" w lateral file pedestal Specify Left or Right (seated)</p>	<u>_R000K-2090-EER</u>	20	90	29¼	
	<u>_R000K-2096-EER</u>	20	96	29¼	
	<u>_R000K-2490-EER</u>	24	90	29¼	
	<u>_R000K-2496-EER</u>	24	96	29¼	
	<hr/>				
		(Right indicated)			
<p>Return</p>  <p>Full finished modesty panel 2- 30" w lateral file pedestals Specify Left or Right (seated)</p>	<u>_R000L-2090-EER</u>	20	90	29¼	
	<u>_R000L-2096-EER</u>	20	96	29¼	
	<u>_R000L-2490-EER</u>	24	90	29¼	
	<u>_R000L-2496-EER</u>	24	96	29¼	
	<hr/>				
		(Right indicated)			
<p>Return</p>  <p>Hinged modesty panel 2- 30" w lateral file pedestals Specify Left or Right (seated)</p>	<u>_R000H-2090-EER</u>	20	90	29¼	
	<u>_R000H-2096-EER</u>	20	96	29¼	
	<u>_R000H-2490-EER</u>	24	90	29¼	
	<u>_R000H-2496-EER</u>	24	96	29¼	
	<hr/>				
		(Right indicated)			

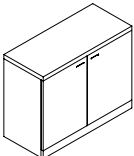
Description	Model Number	Overall Dimensions (in.)			Notes
		Depth	Width	Height	
 Full Storage Credenza	_C000K-2030-HH	20	30	29¼	1 adjustable shelf
	_C000K-2036-HH	20	36	29¼	1 adjustable shelf
	_C000K-2042-HH	20	42	29¼	1 adjustable shelf
	_C000K-2430-HH	24	30	29¼	1 adjustable shelf
	_C000K-2436-HH	24	36	29¼	1 adjustable shelf
	_C000K-2442-HH	24	42	29¼	1 adjustable shelf

Unfinished back

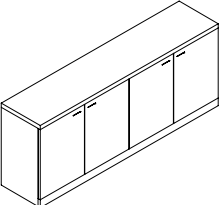
 Full Storage Credenza	_C000K-2060-HHHH	20	60	29¼	2 bay, 1 adjustable shelf each bay
	_C000K-2072-HHHH	20	72	29¼	2 bay, 1 adjustable shelf each bay
	_C000K-2460-HHHH	24	60	29¼	2 bay, 1 adjustable shelf each bay
	_C000K-2472-HHHH	24	72	29¼	2 bay, 1 adjustable shelf each bay

Unfinished back

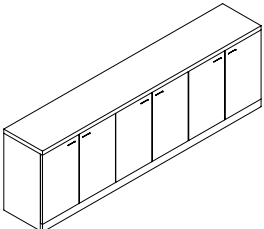
 Full Storage Credenza	_C000K-2084-HHHHHH	20	84	29¼	3 bay, 1 adjustable shelf each bay
	_C000K-2090-HHHHHH	20	90	29¼	3 bay, 1 adjustable shelf each bay
	_C000K-2096-HHHHHH	20	96	29¼	3 bay, 1 adjustable shelf each bay
	_C000K-2484-HHHHHH	24	84	29¼	3 bay, 1 adjustable shelf each bay
	_C000K-2490-HHHHHH	24	90	29¼	3 bay, 1 adjustable shelf each bay
	_C000K-2496-HHHHHH	24	96	29¼	3 bay, 1 adjustable shelf each bay

Unfinished back

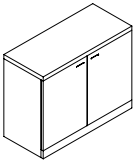
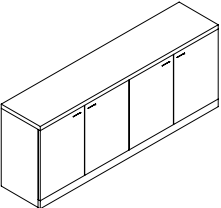
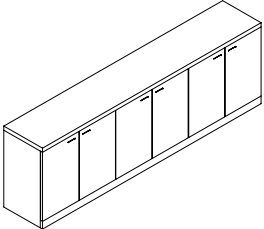
Description	Model Number	Overall Dimensions (in.)			Notes
		Depth	Width	Height	
	_C000L-2030-HH	20	30	29¼	1 adjustable shelf
	_C000L-2036-HH	20	36	29¼	1 adjustable shelf
	_C000L-2042-HH	20	42	29¼	1 adjustable shelf
	_C000L-2430-HH	24	30	29¼	1 adjustable shelf
	_C000L-2436-HH	24	36	29¼	1 adjustable shelf
	_C000L-2442-HH	24	42	29¼	1 adjustable shelf
Full finished modesty panel					
	_C000L-2060-HHHH	20	60	29¼	2 bay, 1 adjustable shelf each bay
	_C000L-2072-HHHH	20	72	29¼	2 bay, 1 adjustable shelf each bay
	_C000L-2460-HHHH	24	60	29¼	2 bay, 1 adjustable shelf each bay
	_C000L-2472-HHHH	24	72	29¼	2 bay, 1 adjustable shelf each bay
Full finished modesty panel					
	_C000L-2084-HHHHHH	20	84	29¼	3 bay, 1 adjustable shelf each bay
	_C000L-2090-HHHHHH	20	90	29¼	3 bay, 1 adjustable shelf each bay
	_C000L-2096-HHHHHH	20	96	29¼	3 bay, 1 adjustable shelf each bay
	_C000L-2484-HHHHHH	24	84	29¼	3 bay, 1 adjustable shelf each bay
	_C000L-2490-HHHHHH	24	90	29¼	3 bay, 1 adjustable shelf each bay
	_C000L-2496-HHHHHH	24	96	29¼	3 bay, 1 adjustable shelf each bay
Full finished modesty panel					

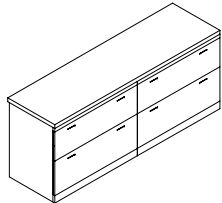
Description	Model Number	Overall Dimensions (in.)			Notes
		Depth	Width	Height	
Freestanding Storage Credenza	_C000N-2060-EE	20	60 ¹ / ₈	29 ¹ / ₄	2-30" w lateral file pedestal
	_C000N-2072-FF	20	72 ¹ / ₈	29 ¹ / ₄	2-36" w lateral file pedestal
	_C000N-2460-EE	24	60 ¹ / ₈	29 ¹ / ₄	2-30" w lateral file pedestal
	_C000N-2472-FF	24	72 ¹ / ₈	29 ¹ / ₄	2-36" w lateral file pedestal

Unfinished back

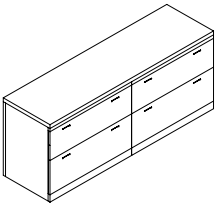
Freestanding Storage Credenza	_C000L-2060 EE	20	60 ¹ / ₈	29 ¹ / ₄	2-30" w lateral file pedestal
	_C000L-2072-FF	20	72 ¹ / ₈	29 ¹ / ₄	2-36" w lateral file pedestal
	_C000L-2460-EE	24	60 ¹ / ₈	29 ¹ / ₄	2-30" w lateral file pedestal
	_C000L-2472-FF	24	72 ¹ / ₈	29 ¹ / ₄	2-36" w lateral file pedestal

Full finished modesty panel

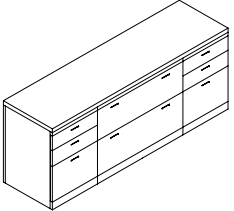
Description	Model Number	Overall Dimensions (in.)			Notes
		Depth	Width	Height	
	_C000N-2068-CEC	20	68½	29¼	2- legal width b/b/f pedestals 30" w lateral file pedestal
	_C000N-2074-CFC	20	73½	29¼	2- legal width b/b/f pedestals 36" w lateral file pedestal
	_C000N-2468-CEC	24	68½	29¼	2- legal width b/b/f pedestals 30" w lateral file pedestal
	_C000N-2474-CFC	24	73½	29¼	2- legal width b/b/f pedestals 36" w lateral file pedestal

Unfinished back

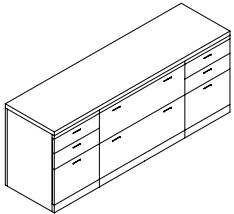
	_C000L-2068-CEC	20	68½	29¼	2- legal width b/b/f pedestals 30" w lateral file pedestal
	_C000L-2074-CFC	20	73½	29¼	2- legal width b/b/f pedestals 36" w lateral file pedestal
	_C000L-2468-CEC	24	68½	29¼	2- legal width b/b/f pedestals 30" w lateral file pedestal
	_C000L-2474-CFC	24	73½	29¼	2- legal width b/b/f pedestals 36" w lateral file pedestal

Full finished modesty panel

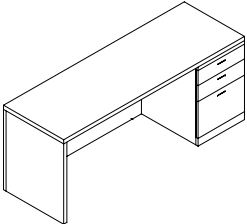
Description	Model Number	Overall Dimensions (in.)			Notes
		Depth	Width	Height	
	_C000L-2060-CR	20	60	29¼	
	_C000L-2066-CR	20	66	29¼	
	_C000L-2072-CR	20	72	29¼	
	_C000L-2078-CR	20	78	29¼	
	_C000L-2084-CR	20	84	29¼	
	_C000L-2090-CR	20	90	29¼	
	_C000L-2096-CR	20	96	29¼	
	_C000L-2460-CR	24	60	29¼	
	_C000L-2466-CR	24	66	29¼	
	_C000L-2472-CR	24	72	29¼	
	_C000L-2478-CR	24	78	29¼	
	_C000L-2484-CR	24	84	29¼	
	_C000L-2490-CR	24	90	29¼	
	_C000L-2496-CR	24	96	29¼	

Full finished modesty panel
 Legal width b/b/f pedestal
 Specify **Left** or **Right** (seated)

(**Right** indicated)

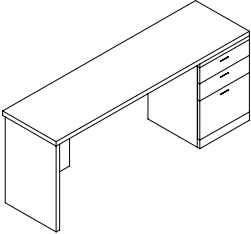
	_C000K-2060-CR	20	60	29¼	
	_C000K-2066-CR	20	66	29¼	
	_C000K-2072-CR	20	72	29¼	
	_C000K-2078-CR	20	78	29¼	
	_C000K-2084-CR	20	84	29¼	
	_C000K-2090-CR	20	90	29¼	
	_C000K-2096-CR	20	96	29¼	
	_C000K-2460-CR	24	60	29¼	
	_C000K-2466-CR	24	66	29¼	
	_C000K-2472-CR	24	72	29¼	
	_C000K-2478-CR	24	78	29¼	
	_C000K-2484-CR	24	84	29¼	
	_C000K-2490-CR	24	90	29¼	
	_C000K-2496-CR	24	96	29¼	

Open back with keel
 Legal width b/b/f pedestal
 Specify **Left** or **Right** (seated)

(**Right** indicated)

note: unfinished black pedestal back

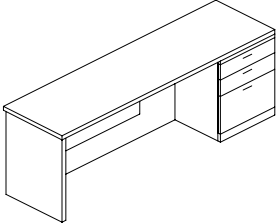
Description	Model Number	Overall Dimensions (in.)			Notes
		Depth	Width	Height	
Credenza 	_C000H-2060-CR	20	60	29¼	
	_C000H-2066-CR	20	66	29¼	
	_C000H-2072-CR	20	72	29¼	
	_C000H-2078-CR	20	78	29¼	
	_C000H-2084-CR	20	84	29¼	
	_C000H-2090-CR	20	90	29¼	
	_C000H-2096-CR	20	96	29¼	
	_C000H-2460-CR	24	60	29¼	
	_C000H-2466-CR	24	66	29¼	
	_C000H-2472-CR	24	72	29¼	
	_C000H-2478-CR	24	78	29¼	
	_C000H-2484-CR	24	84	29¼	
	_C000H-2490-CR	24	90	29¼	
	_C000H-2496-CR	24	96	29¼	
	Hinged modesty panel Legal width b/b/f pedestal Specify Left or Right (seated)	(Right indicated)			

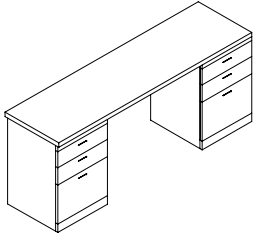
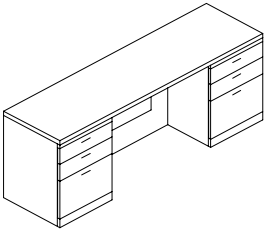
Description	Model Number	Overall Dimensions (in.)			Notes	
		Depth	Width	Height		
Credenza 	_C000K-2066-CKC	20	66	29¼		
	_C000K-2072-CKC	20	72	29¼		
	_C000K-2078-CKC	20	78	29¼		
	_C000K-2084-CKC	20	84	29¼		
	_C000K-2090-CKC	20	90	29¼		
	_C000K-2096-CKC	20	96	29¼		
	_C000K-2466-CKC	24	66	29¼		
	_C000K-2472-CKC	24	72	29¼		
	_C000K-2478-CKC	24	78	29¼		
	_C000K-2484-CKC	24	84	29¼		
	_C000K-2490-CKC	24	90	29¼		
	_C000K-2496-CKC	24	96	29¼		
	Open back with keel 2 legal width b/b/f pedestals					(note: unfinished black pedestal back)
	Credenza 	_C000H-2066-CKC	20	66	29¼	
_C000H-2072-CKC		20	72	29¼		
_C000H-2078-CKC		20	78	29¼		
_C000H-2084-CKC		20	84	29¼		
_C000H-2090-CKC		20	90	29¼		
_C000H-2096-CKC		20	96	29¼		
_C000H-2466-CKC		24	66	29¼		
_C000H-2472-CKC		24	72	29¼		
_C000H-2478-CKC		24	78	29¼		
_C000H-2484-CKC		24	84	29¼		
_C000H-2490-CKC		24	90	29¼		
_C000H-2496-CKC		24	96	29¼		
Hinged modesty panel 2 legal width b/b/f pedestals						(note: unfinished black back)

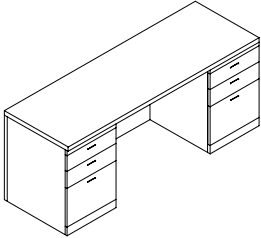
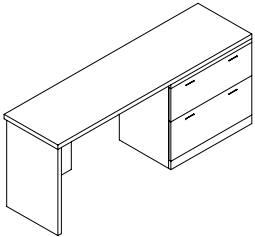
Description	Model Number	Overall Dimensions (in.)			Notes	
		Depth	Width	Height		
Credenza 	_C000L-2066-CKC	20	66	29¼		
	_C000L-2072-CKC	20	72	29¼		
	_C000L-2078-CKC	20	78	29¼		
	_C000L-2084-CKC	20	84	29¼		
	_C000L-2090-CKC	20	90	29¼		
	_C000L-2096-CKC	20	96	29¼		
	_C000L-2466-CKC	24	66	29¼		
	_C000L-2472-CKC	24	72	29¼		
	_C000L-2478-CKC	24	78	29¼		
	_C000L-2484-CKC	24	84	29¼		
	_C000L-2490-CKC	24	90	29¼		
	_C000L-2496-CKC	24	96	29¼		
	Full finished modesty panel 2 legal width b/b/f pedestals					
	Credenza 	_C000K-2060-ER	20	60	29¼	
_C000K-2066-ER		20	66	29¼		
_C000K-2072-ER		20	72	29¼		
_C000K-2078-ER		20	78	29¼		
_C000K-2084-ER		20	84	29¼		
_C000K-2090-ER		20	90	29¼		
_C000K-2096-ER		20	96	29¼		
_C000K-2460-ER		24	60	29¼		
_C000K-2466-ER		24	66	29¼		
_C000K-2472-ER		24	72	29¼		
_C000K-2478-ER		24	78	29¼		
_C000K-2484-ER		24	84	29¼		
_C000K-2490-ER		24	90	29¼		
_C000K-2496-ER		24	96	29¼		
Open back with keel 30" w lateral file pedestal Specify Left or Right (seated) (Right indicated) (note: unfinished black pedestal back)						

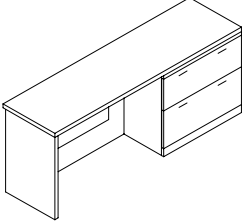
Description	Model Number	Overall Dimensions (in.)			Notes
		Depth	Width	Height	
Credenza 	_C000H-2066-ER	20	66	29¼	
	_C000H-2072-ER	20	72	29¼	
	_C000H-2078-ER	20	78	29¼	
	_C000H-2084-ER	20	84	29¼	
	_C000H-2090-ER	20	90	29¼	
	_C000H-2096-ER	20	96	29¼	
	_C000H-2466-ER	24	66	29¼	
	_C000H-2472-ER	24	72	29¼	
	_C000H-2478-ER	24	78	29¼	
	_C000H-2484-ER	24	84	29¼	
	_C000H-2490-ER	24	90	29¼	
	_C000H-2496-ER	24	96	29¼	

Hinged modesty panel
 30" w lateral file pedestal
 Specify **Left** or **Right** (seated)

(**R**ight indicated)

(note: unfinished black back)

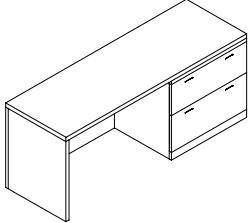
Credenza 	_C000L-2066-ER	20	66	29¼	
	_C000L-2072-ER	20	72	29¼	
	_C000L-2078-ER	20	78	29¼	
	_C000L-2084-ER	20	84	29¼	
	_C000L-2090-ER	20	90	29¼	
	_C000L-2096-ER	20	96	29¼	
	_C000L-2466-ER	24	66	29¼	
	_C000L-2472-ER	24	72	29¼	
	_C000L-2478-ER	24	78	29¼	
	_C000L-2484-ER	24	84	29¼	
	_C000L-2490-ER	24	90	29¼	
	_C000L-2496-ER	24	96	29¼	

Full finished modesty panel
 30" w lateral file pedestal
 Specify **Left** or **Right** (seated)

(**R**ight indicated)

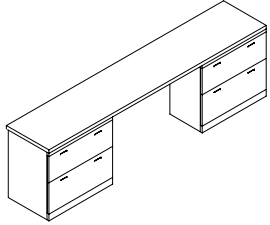
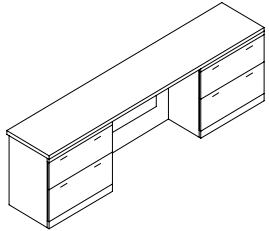
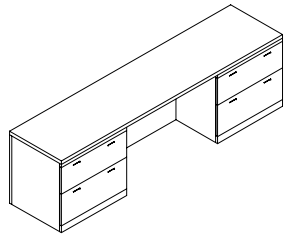
Description	Model Number	Overall Dimensions (in.)			Notes
		Depth	Width	Height	
Credenza 	_C000K-2090-EKE	20	90	29¼	(note: unfinished black back)
	_C000K-2096-EKE	20	96	29¼	
	_C000K-2490-EKE	24	90	29¼	
	_C000K-2496-EKE	24	96	29¼	
	Open back with keel 2- 30"w lateral file pedestals				
Credenza 	_C000H-2090-EKE	20	90	29¼	(note: unfinished black pedestal back)
	_C000H-2096-EKE	20	96	29¼	
	_C000H-2490-EKE	24	90	29¼	
	_C000H-2496-EKE	24	96	29¼	
	Hinged modesty panel 2- 30"w lateral file pedestals				
Credenza 	_C000L-2090-EKE	20	90	29¼	
	_C000L-2096-EKE	20	96	29¼	
	_C000L-2490-EKE	24	90	29¼	
	_C000L-2496-EKE	24	96	29¼	
	Full finished modesty panel 2- 30"w lateral file pedestals				

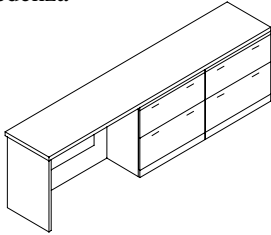
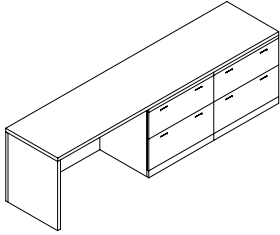
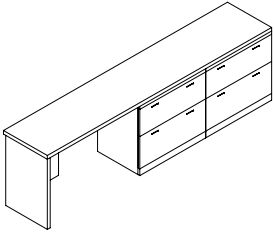
Description	Model Number	Overall Dimensions (in.)			Notes
		Depth	Width	Height	
Credenza 	_C000H-2090-EER	20	90	29¼	
	_C000H-2096-EER	20	96	29¼	
	_C000H-2490-EER	24	90	29¼	
	_C000H-2496-EER	24	96	29¼	
Hinged modesty panel 2- 30"w lateral file pedestals Specify Left or Right (seated)		(Right indicated)			(note: unfinished black back)
Credenza 	_C000L-2090-EER	20	90	29¼	
	_C000L-2096-EER	20	96	29¼	
	_C000L-2490-EER	24	90	29¼	
	_C000L-2496-EER	24	96	29¼	
Full finished modesty panel 2- 30"w lateral file pedestals Specify Left or Right (seated)		(Right indicated)			
Credenza 	_C000K-2090-EER	20	90	29¼	
	_C000K-2096-EER	20	96	29¼	
	_C000K-2490-EER	24	90	29¼	
	_C000K-2496-EER	24	96	29¼	
Open back with keel 2- 30"w lateral file pedestals Specify Left or Right (seated)		(Right indicated)			(note: unfinished black pedestal back)

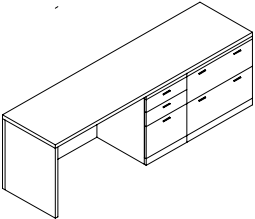
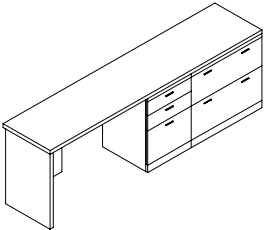
Description	Model Number	Overall Dimensions (in.)			Notes
		Depth	Width	Height	
<p>Credenza</p> 	_C000L-2078-CER	20	78	29¼	
	_C000L-2084-CER	20	84	29¼	
	_C000L-2090-CER	20	90	29¼	
	_C000L-2096-CER	20	96	29¼	
	_C000L-2478-CER	24	78	29¼	
	_C000L-2484-CER	24	84	29¼	
	_C000L-2490-CER	24	90	29¼	
	_C000L-2496-CER	24	96	29¼	
	<p>Full finished modesty panel Legal width b/b/f pedestal and 30" w lateral file pedestal Specify Left or Right (seated) (Right indicated)</p>				
	<p>Credenza</p> 	_C000K-2078-CER	20	78	29¼
_C000K-2084-CER		20	84	29¼	
_C000K-2090-CER		20	90	29¼	
_C000K-2096-CER		20	96	29¼	
_C000K-2478-CER		24	78	29¼	
_C000K-2484-CER		24	84	29¼	
_C000K-2490-CER		24	90	29¼	
_C000K-2496-CER		24	96	29¼	
<p>Open back with keel Legal width b/b/f pedestal and 30" w lateral file pedestal Specify Left or Right (seated) (Right indicated)</p>					
(note: unfinished black pedestal back)					

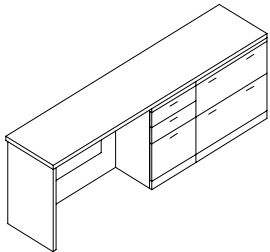
Description	Model Number	Overall Dimensions (in.)			Notes	
		Depth	Width	Height		
<p>Credenza</p> 	_C000H-2078-CER	20	78	29¼		
	_C000H-2084-CER	20	84	29¼		
	_C000H-2090-CER	20	90	29¼		
	_C000H-2096-CER	20	96	29¼		
	_C000H-2478-CER	24	78	29¼		
	_C000H-2484-CER	24	84	29¼		
	_C000H-2490-CER	24	90	29¼		
	_C000H-2496-CER	24	96	29¼		
	Hinged modesty panel					
	Legal width b/b/f pedestal and 30" w lateral file pedestal					
Specify Left or Right (seated)	(Right indicated)				(note: unfinished black back)	

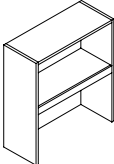
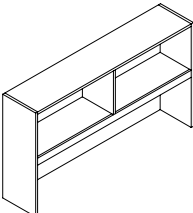
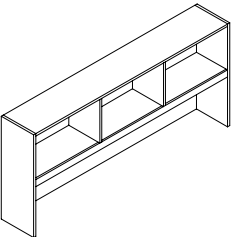
Description	Model Number	Overall Dimensions (in.)			Notes
		Depth	Width	Height	
 <p>Open Storage Hi-Rise</p>	xSUN10-1436	14¼	36	41¼	
	xSUN10-1442	14¼	42	41¼	
	xSUN11-1436	14¼	36	53¼	1 adjustable shelf
	xSUN11-1442	14¼	42	53¼	1 adjustable shelf
	1 bay				
	<hr/>				
 <p>Open Storage Hi-Rise</p>	xSUN20-1448	14¼	48	41¼	
	xSUN20-1454	14¼	54	41¼	
	xSUN20-1460	14¼	60	41¼	
	xSUN20-1466	14¼	66	41¼	
	xSUN20-1472	14¼	72	41¼	
	xSUN20-1478	14¼	78	41¼	
	xSUN21-1448	14¼	48	53¼	1 adjustable shelf each bay
	xSUN21-1454	14¼	54	53¼	1 adjustable shelf each bay
	xSUN21-1460	14¼	60	53¼	1 adjustable shelf each bay
	xSUN21-1466	14¼	66	53¼	1 adjustable shelf each bay
	xSUN21-1472	14¼	72	53¼	1 adjustable shelf each bay
	xSUN21-1478	14¼	78	53¼	1 adjustable shelf each bay
	2 bay				
	<hr/>				
 <p>Open Storage Hi-Rise</p>	xSUN30-1484	14¼	84	41¼	
	xSUN30-1490	14¼	90	41¼	
	xSUN30-1496	14¼	96	41¼	
	xSUN31-1484	14¼	84	53¼	1 adjustable shelf each bay
	xSUN31-1490	14¼	90	53¼	1 adjustable shelf each bay
	xSUN31-1496	14¼	96	53¼	1 adjustable shelf each bay
	3 bay				

(note: all units on this page have unfinished backs)
(see page 60-61 for detailed top trim)

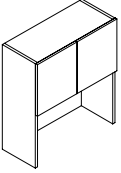
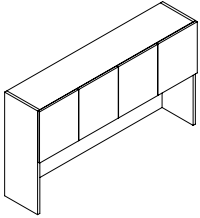
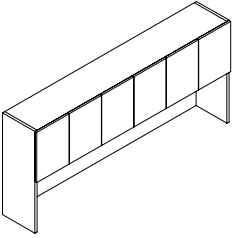
Description	Model Number	Overall Dimensions (in.)			Notes	
		Depth	Width	Height		
 <p>Hinged Door Hi-Rise Storage</p> <p>1 bay, 2 hinged doors</p>	xSUH10-1536	15	36	41¼		
	xSUH10-1542	15	42	41¼		
	xSUH11-1536	15	36	53¼	1 adjustable shelf	
	xSUH11-1542	15	42	53¼	1 adjustable shelf	
	xSUH20-1548	15	48	41¼		
	xSUH20-1554	15	54	41¼		
 <p>Hinged Door Hi-Rise Storage</p> <p>2 bay, 4 hinged doors</p>	xSUH20-1560	15	60	41¼		
	xSUH20-1566	15	66	41¼		
	xSUH20-1572	15	72	41¼		
	xSUH20-1578	15	78	41¼		
	xSUH21-1548	15	48	53¼	1 adjustable shelf each bay	
	xSUH21-1554	15	54	53¼	1 adjustable shelf each bay	
	xSUH21-1560	15	60	53¼	1 adjustable shelf each bay	
	xSUH21-1566	15	66	53¼	1 adjustable shelf each bay	
	xSUH21-1572	15	72	53¼	1 adjustable shelf each bay	
	xSUH21-1578	15	78	53¼	1 adjustable shelf each bay	
	 <p>Hinged Door Hi-Rise Storage</p> <p>3 bay, 6 hinged doors</p>	xSUH30-1584	15	84	41¼	
		xSUH30-1590	15	90	41¼	
xSUH30-1596		15	96	41¼		
xSUH31-1584		15	84	53¼	1 adjustable shelf each bay	
xSUH31-1590		15	90	53¼	1 adjustable shelf each bay	
xSUH31-1596		15	96	53¼	1 adjustable shelf each bay	

(note: all units on this page have unfinished backs)
(see page 60 for detailed top trim)

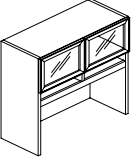
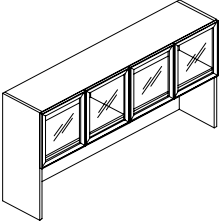
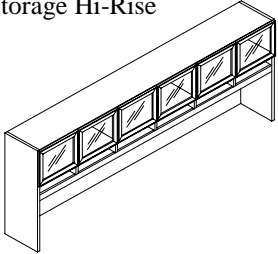
Description	Model Number	Overall Dimensions (in.)			Notes
		Depth	Width	Height	
 <p>Open Storage Hi-Rise</p>	xSUH100A-1536	15	36	41¼	
	xSUH100A-1542	15	42	41¼	
	xSUH110A-1536	15	36	53¼	1 adjustable shelf
	xSUH110A-1542	15	42	53¼	1 adjustable shelf
	1 bay				
	2 metal framed frosted glass doors				
 <p>Open Storage Hi-Rise</p>	xSUH200A-1548	15	48	41¼	
	xSUH200A-1554	15	54	41¼	
	xSUH200A-1560	15	60	41¼	
	xSUH200A-1566	15	66	41¼	
	xSUH200A-1572	15	72	41¼	
	xSUH200A-1578	15	78	41¼	
	xSUH210A-1548	15	48	53¼	1 adjustable shelf each bay
	xSUH210A-1554	15	54	53¼	1 adjustable shelf each bay
	xSUH210A-1560	15	60	53¼	1 adjustable shelf each bay
	xSUH210A-1566	15	66	53¼	1 adjustable shelf each bay
	xSUH210A-1572	15	72	53¼	1 adjustable shelf each bay
	xSUH210A-1578	15	78	53¼	1 adjustable shelf each bay
	2 bay				
	4 metal framed frosted glass doors				
 <p>Open Storage Hi-Rise</p>	xSUH300A-1584	15	84	41¼	
	xSUH300A-1590	15	90	41¼	
	xSUH300A-1596	15	96	41¼	
	xSUH310A-1584	15	84	53¼	1 adjustable shelf each bay
	xSUH310A-1590	15	90	53¼	1 adjustable shelf each bay
	xSUH310A-1596	15	96	53¼	1 adjustable shelf each bay
	3 bay				
	6 metal framed frosted glass doors				

(note: all units on this page have unfinished backs)
 (see page 60-61 for detailed top trim)

Description	Model Number	Overall Dimensions (in.)			Notes
		Depth	Width	Height	
Hinged Door Hi-Rise Storage	xSUH100F-1536	15	36	41¼	
	xSUH100F-1542	15	42	41¼	

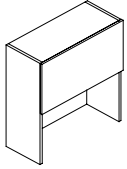

1 bay, 1 flipper door

Hinged Door Hi-Rise Storage	xSUH200F-1548	15	48	41¼	
	xSUH200F-1554	15	54	41¼	
	xSUH200F-1560	15	60	41¼	
	xSUH200F-1566	15	66	41¼	
	xSUH200F-1572	15	72	41¼	
	xSUH200F-1578	15	78	41¼	

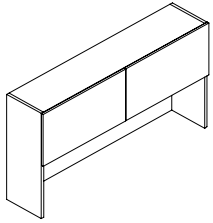

2 bay, 2 flipper doors

Hinged Door Hi-Rise Storage	xSUH300F-1584	15	84	41¼	
	xSUH300F-1590	15	90	41¼	
	xSUH300F-1596	15	96	41¼	

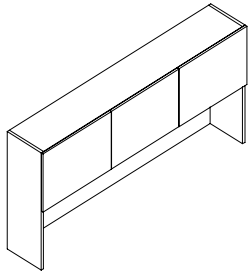

3 bay, 3 flipper doors

(note: all units on this page have unfinished backs)
(see page 60 for detailed top trim)

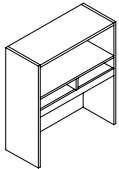
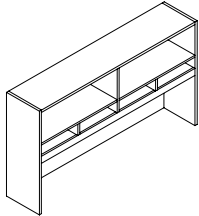
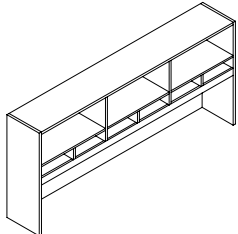
Description	Model Number	Overall Dimensions (in.)			Notes
		Depth	Width	Height	
Open Storage Hi-Rise with Organizer  1 bay	xSUO100-1436	14¼	36	41¼	
	xSUO100-1442	14¼	42	41¼	
	xSUO110-1436	14¼	36	53¼	1 adjustable shelf
	xSUO110-1442	14¼	42	53¼	1 adjustable shelf
	<hr/>				
	Open Storage Hi-Rise with Organizer  2 bay	xSUO200-1448	14¼	48	41¼
xSUO200-1454		14¼	54	41¼	
xSUO200-1460		14¼	60	41¼	
xSUO200-1466		14¼	66	41¼	
xSUO200-1472		14¼	72	41¼	
xSUO200-1478		14¼	78	41¼	
xSUO210-1448		14¼	48	53¼	1 adjustable shelf each bay
xSUO210-1454		14¼	54	53¼	1 adjustable shelf each bay
xSUO210-1460		14¼	60	53¼	1 adjustable shelf each bay
xSUO210-1466		14¼	66	53¼	1 adjustable shelf each bay
xSUO210-1472		14¼	72	53¼	1 adjustable shelf each bay
xSUO210-1478		14¼	78	53¼	1 adjustable shelf each bay
<hr/>					
Open Storage Hi-Rise with Organizer  3 bay		xSUO300-1484	14¼	84	41¼
	xSUO300-1490	14¼	90	41¼	
	xSUO300-1496	14¼	96	41¼	
	xSUO310-1484	14¼	84	53¼	1 adjustable shelf each bay
	xSUO310-1490	14¼	90	53¼	1 adjustable shelf each bay
	xSUO310-1496	14¼	96	53¼	1 adjustable shelf each bay
	<hr/>				
	(note: all units on this page have unfinished backs) (see page 60-61 for detailed top trim)				

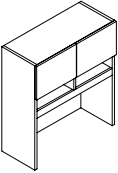
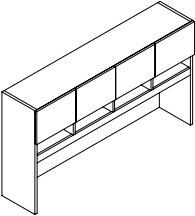
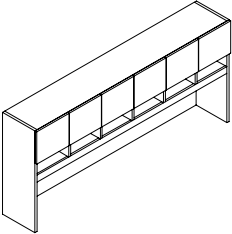
Description	Model Number	Overall Dimensions (in.)			Notes
		Depth	Width	Height	
Hinged Door Hi-Rise Storage with Organizer Below	xSUD10-1536	15	36	41¼	
	xSUD10-1542	15	42	41¼	
	xSUD11-1536	15	36	53¼	1 adjustable shelf
	xSUD11-1542	15	42	53¼	1 adjustable shelf
1 bay, 2 hinged doors					
Hinged Door Hi-Rise Storage with Organizer Below	xSUD20-1548	15	48	41¼	
	xSUD20-1554	15	54	41¼	
	xSUD20-1560	15	60	41¼	
	xSUD20-1566	15	66	41¼	
	xSUD20-1572	15	72	41¼	
	xSUD20-1578	15	78	41¼	
	xSUD21-1548	15	48	53¼	1 adjustable shelf each bay
	xSUD21-1554	15	54	53¼	1 adjustable shelf each bay
	xSUD21-1560	15	60	53¼	1 adjustable shelf each bay
	xSUD21-1566	15	66	53¼	1 adjustable shelf each bay
	xSUD21-1572	15	72	53¼	1 adjustable shelf each bay
	xSUD21-1578	15	78	53¼	1 adjustable shelf each bay
2 bay, 4 hinged doors					
Hinged Door Hi-Rise Storage with Organizer Below	xSUD30-1584	15	84	41¼	
	xSUD30-1590	15	90	41¼	
	xSUD30-1596	15	96	41¼	
	xSUD31-1584	15	84	53¼	1 adjustable shelf each bay
	xSUD31-1590	15	90	53¼	1 adjustable shelf each bay
	xSUD31-1596	15	96	53¼	1 adjustable shelf each bay
3 bay, 6 hinged doors					

(note: all units on this page have unfinished
(note: see page 60-61 for detailed top trim)

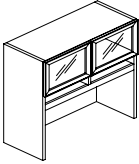
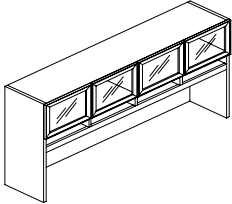
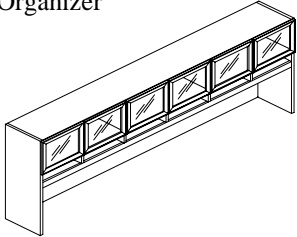
Description	Model Number	Overall Dimensions (in.)			Notes
		Depth	Width	Height	
Open Storage Hi-Rise with Organizer 	xSUD100A-1536	15	36	41¼	
	xSUD100A-1542	15	42	41¼	
	xSUD110A-1536	15	36	53¼	1 adjustable shelf
	xSUD110A-1542	15	42	53¼	1 adjustable shelf
	1 bay				
	2 metal framed frosted glass doors				
Open Storage Hi-Rise with Organizer 	xSUD200A-1548	15	48	41¼	
	xSUD200A-1554	15	54	41¼	
	xSUD200A-1560	15	60	41¼	
	xSUD200A-1566	15	66	41¼	
	xSUD200A-1572	15	72	41¼	
	xSUD200A-1578	15	78	41¼	
	xSUD210A-1548	15	48	53¼	1 adjustable shelf each bay
	xSUD210A-1554	15	54	53¼	1 adjustable shelf each bay
	xSUD210A-1560	15	60	53¼	1 adjustable shelf each bay
	xSUD210A-1566	15	66	53¼	1 adjustable shelf each bay
	xSUD210A-1572	15	72	53¼	1 adjustable shelf each bay
	xSUD210A-1578	15	78	53¼	1 adjustable shelf each bay
	2 bay				
	4 metal framed frosted glass doors				
Open Storage Hi-Rise with Organizer 	xSUD300A-1584	15	84	41¼	
	xSUD300A-1590	15	90	41¼	
	xSUD300A-1596	15	96	41¼	
	xSUD310A-1584	15	84	53¼	1 adjustable shelf each bay
	xSUD310A-1590	15	90	53¼	1 adjustable shelf each bay
	xSUD310A-1596	15	96	53¼	1 adjustable shelf each bay
	3 bay				
	6 metal framed frosted glass doors				
					(note: all units on this page have unfinished backs) (see page 60-61 for detailed top trim)

Description	Model Number	Overall Dimensions (in.)			Notes
		Depth	Width	Height	
Hinged Door Hi-Rise Storage with Organizer Below	xSUD100F-1536	15	36	41¼	
	xSUD100F-1542	15	42	41¼	

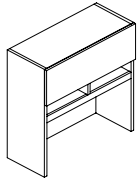

1 bay, 1 flipper door

Hinged Door Hi-Rise Storage with Organizer Below	xSUD200F-1548	15	48	41¼	
	xSUD200F-1554	15	54	41¼	
	xSUD200F-1560	15	60	41¼	
	xSUD200F-1566	15	66	41¼	
	xSUD200F-1572	15	72	41¼	
	xSUD200F-1578	15	78	41¼	

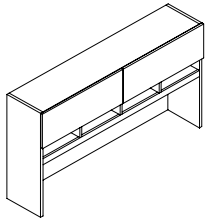

2 bay, 2 flipper doors

Hinged Door Hi-Rise Storage with Organizer Below	xSUD300F-1584	15	84	41¼	
	xSUD300F-1590	15	90	41¼	
	xSUD300F-1596	15	96	41¼	

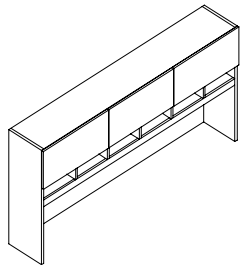

3 bay, 3 flipper doors

(note: all units on this page have unfinished backs)
(see page 60-61 for detailed top trim)

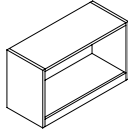
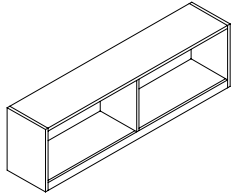
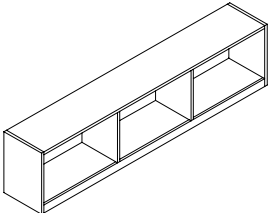
Description	Model Number	Overall Dimensions (in.)			Notes		
		Depth	Width	Height			
	Wall Mount/Spanner Storage	xSWN10-1430	14¼	30	20¾		
		xSWN10-1436	14¼	36	20¾		
		xSWN10-1442	14¼	42	20¾		
		xSWN11-1430	14¼	30	32¾	1 adjustable shelf	
		xSWN11-1436	14¼	36	32¾	1 adjustable shelf	
		xSWN11-1442	14¼	42	32¾	1 adjustable shelf	
	1 bay	Please specify Wall Mount or Spanner Cabinet.					
		Wall Mount/Spanner Storage	xSWN20-1448	14¼	48	20¾	
			xSWN20-1454	14¼	54	20¾	
		xSWN20-1460	14¼	60	20¾		
		xSWN20-1466	14¼	66	20¾		
		xSWN20-1472	14¼	72	20¾		
		xSWN20-1478	14¼	78	20¾		
		xSWN21-1448	14¼	48	32¾	1 adjustable shelf each bay	
		xSWN21-1454	14¼	54	32¾	1 adjustable shelf each bay	
		xSWN21-1460	14¼	60	32¾	1 adjustable shelf each bay	
		xSWN21-1466	14¼	66	32¾	1 adjustable shelf each bay	
		xSWN21-1472	14¼	72	32¾	1 adjustable shelf each bay	
		xSWN21-1478	14¼	78	32¾	1 adjustable shelf each bay	
2 bay		Please specify Wall Mount or Spanner Cabinet.					
		Wall Mount/Spanner Storage	xSWN30-1484	14¼	84	20¾	
			xSWN30-1490	14¼	90	20¾	
		xSWN30-1496	14¼	96	20¾		
		xSWN31-1484	14¼	84	32¾	1 adjustable shelf each bay	
		xSWN31-1490	14¼	90	32¾	1 adjustable shelf each bay	
		xSWN31-1496	14¼	96	32¾	1 adjustable shelf each bay	
	3 bay	Please specify Wall Mount or Spanner Cabinet.					

(note: all units on this page have unfinished backs)
(see page 60-61 for detailed top trim)

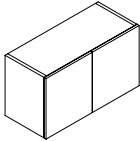
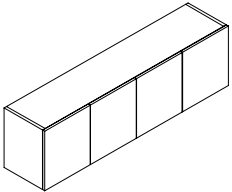
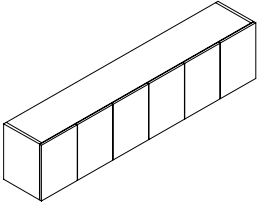
Description	Model Number	Overall Dimensions (in.)			Notes	
		Depth	Width	Height		
Wall Mount/Spanner Storage with Doors 	xSWH10-1530	15	30	20¾		
	xSWH10-1536	15	36	20¾		
	xSWH10-1542	15	42	20¾		
	xSWH11-1530	15	30	32¾	1 adjustable shelf	
	xSWH11-1536	15	36	32¾	1 adjustable shelf	
	xSWH11-1542	15	42	32¾	1 adjustable shelf	
	1 bay, 2 hinged doors Please specify Wall Mount or Spanner Cabinet.					
	Wall Mount/Spanner Storage with Doors 	xSWH20-1548	15	48	20¾	
		xSWH20-1554	15	54	20¾	
xSWH20-1560		15	60	20¾		
xSWH20-1566		15	66	20¾		
xSWH20-1572		15	72	20¾		
xSWH20-1578		15	78	20¾		
xSWH21-1548		15	48	32¾	1 adjustable shelf each bay	
xSWH21-1554		15	54	32¾	1 adjustable shelf each bay	
xSWH21-1560		15	60	32¾	1 adjustable shelf each bay	
xSWH21-1566		15	66	32¾	1 adjustable shelf each bay	
xSWH21-1572		15	72	32¾	1 adjustable shelf each bay	
xSWH21-1578		15	78	32¾	1 adjustable shelf each bay	
2 bay, 4 hinged doors Please specify Wall Mount or Spanner Cabinet.						
Wall Mount/Spanner Storage with Doors 		xSWH30-1584	15	84	20¾	
		xSWH30-1590	15	90	20¾	
	xSWH30-1596	15	96	20¾		
	xSWH31-1584	15	84	32¾	1 adjustable shelf each bay	
	xSWH31-1590	15	90	32¾	1 adjustable shelf each bay	
	xSWH31-1596	15	96	32¾	1 adjustable shelf each bay	
	3 bay, 6 hinged doors Please specify Wall Mount or Spanner Cabinet.					
	(note: all units on this page have unfinished backs) (see page 60-61 for detailed top trim)					

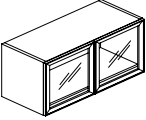
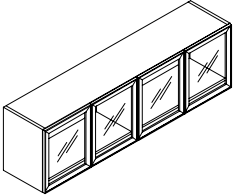
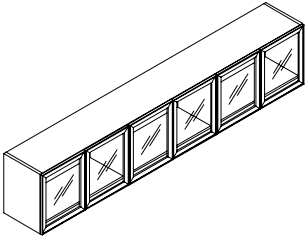
Description	Model Number	Overall Dimensions (in.)			Notes
		Depth	Width	Height	
 <p>1 bay 2 metal framed frosted glass doors</p>	xSWH100A-1530	15	30	20 ³ / ₄	
	xSWH100A-1536	15	36	20 ³ / ₄	
	xSWH100A-1542	15	42	20 ³ / ₄	
	xSWH110A-1530	15	30	32 ³ / ₄	1 adjustable shelf
	xSWH110A-1536	15	36	32 ³ / ₄	1 adjustable shelf
	xSWH110A-1542	15	42	32 ³ / ₄	1 adjustable shelf
	Please specify Wall Mount or Spanner Cabinet.				
	<hr/>				
	 <p>2 bay 4 metal framed frosted glass doors</p>	xSWH200A-1548	15	48	20 ³ / ₄
xSWH200A-1554		15	54	20 ³ / ₄	
xSWH200A-1560		15	60	20 ³ / ₄	
xSWH200A-1566		15	66	20 ³ / ₄	
xSWH200A-1572		15	72	20 ³ / ₄	
xSWH200A-1578		15	78	20 ³ / ₄	
xSWH210A-1548		15	48	32 ³ / ₄	1 adjustable shelf each bay
xSWH210A-1554		15	54	32 ³ / ₄	1 adjustable shelf each bay
xSWH210A-1560		15	60	32 ³ / ₄	1 adjustable shelf each bay
xSWH210A-1566		15	66	32 ³ / ₄	1 adjustable shelf each bay
xSWH210A-1572		15	72	32 ³ / ₄	1 adjustable shelf each bay
xSWH210A-1578		15	78	32 ³ / ₄	1 adjustable shelf each bay
Please specify Wall Mount or Spanner Cabinet.					
<hr/>					
 <p>3 bay 6 metal framed frosted glass doors</p>		xSWH300A-1584	15	84	20 ³ / ₄
	xSWH300A-1590	15	90	20 ³ / ₄	
	xSWH300A-1596	15	96	20 ³ / ₄	
	xSWH310A-1584	15	84	32 ³ / ₄	1 adjustable shelf each bay
	xSWH310A-1590	15	90	32 ³ / ₄	1 adjustable shelf each bay
	xSWH310A-1596	15	96	32 ³ / ₄	1 adjustable shelf each bay
	Please specify Wall Mount or Spanner Cabinet.				
	<hr/>				
	(note: all units on this page have unfinished backs) (see page 60 -61 for detailed top trim)				

Description	Model Number	Overall Dimensions (in.)			Notes
		Depth	Width	Height	

Wall Mount/Spanner Storage with Doors	xSWH100F-1530	15	30	20¾	
	xSWH100F-1536	15	36	20¾	
	xSWH100F-1542	15	42	20¾	

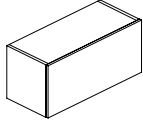

1 bay, 1 flipper door

Please specify Wall Mount or Spanner Cabinet.

Wall Mount/Spanner Storage with Doors	xSWH200F-1548	15	48	20¾	
	xSWH200F-1554	15	54	20¾	
	xSWH200F-1560	15	60	20¾	

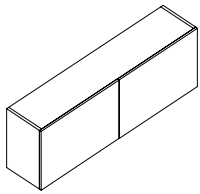

xSWH200F-1566	15	66	20¾	
xSWH200F-1572	15	72	20¾	
xSWH200F-1578	15	78	20¾	

2 bay, 2 flipper doors

Wall Mount/Spanner Storage with Doors	xSWH300F-1584	15	84	20¾	
	xSWH300F-1590	15	90	20¾	
	xSWH300F-1596	15	96	20¾	

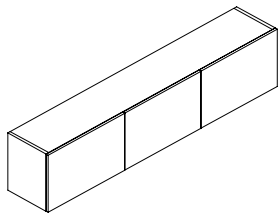

3 bay, 3 flipper doors

Please specify Wall Mount or Spanner Cabinet.

(note: all units on this page have unfinished backs)
(see page 60-61 for detailed top trim)

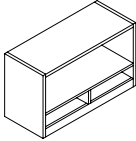
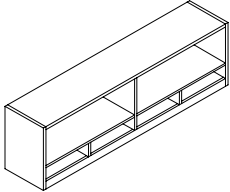
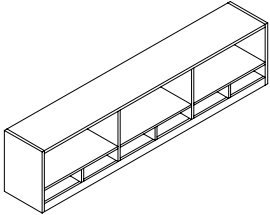
Description	Model Number	Overall Dimensions (in.)			Notes	
		Depth	Width	Height		
Wall Mount/Spanner Storage with Organizer Below 	xSWO10-1430	14¼	30	20¾		
	xSWO10-1436	14¼	36	20¾		
	xSWO10-1442	14¼	42	20¾		
	xSWO11-1430	14¼	30	32¾	1 adjustable shelf	
	xSWO11-1436	14¼	36	32¾	1 adjustable shelf	
	xSWO11-1442	14¼	42	32¾	1 adjustable shelf	
	1 bay Please specify Wall Mount or Spanner Cabinet.					
	Wall Mount/Spanner Storage with Organizer Below 	xSWO20-1448	14¼	48	20¾	
		xSWO20-1454	14¼	54	20¾	
xSWO20-1460		14¼	60	20¾		
xSWO20-1466		14¼	66	20¾		
xSWO20-1472		14¼	72	20¾		
xSWO20-1478		14¼	78	20¾		
xSWO21-1448		14¼	48	32¾	1 adjustable shelf each bay	
xSWO21-1454		14¼	54	32¾	1 adjustable shelf each bay	
xSWO21-1460		14¼	60	32¾	1 adjustable shelf each bay	
xSWO21-1466		14¼	66	32¾	1 adjustable shelf each bay	
xSWO21-1472		14¼	72	32¾	1 adjustable shelf each bay	
xSWO21-1478		14¼	78	32¾	1 adjustable shelf each bay	
2 bay Please specify Wall Mount or Spanner Cabinet.						
Wall Mount/Spanner Storage with Organizer Below 		xSWO30-1484	14¼	84	20¾	
		xSWO30-1490	14¼	90	20¾	
	xSWO30-1496	14¼	96	20¾		
	xSWO31-1484	14¼	84	32¾	1 adjustable shelf each bay	
	xSWO31-1490	14¼	90	32¾	1 adjustable shelf each bay	
	xSWO31-1496	14¼	96	32¾	1 adjustable shelf each bay	
	3 bay Please specify Wall Mount or Spanner Cabinet.					
	(note: all units on this page have unfinished backs) (see page 60-61 for detailed top trim)					

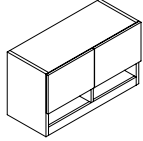
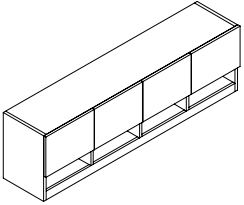
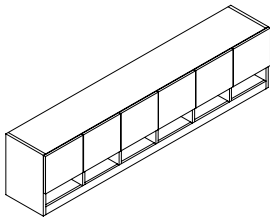
Description	Model Number	Overall Dimensions (in.)			Notes	
		Depth	Width	Height		
Wall Mount/Spanner Storage with Doors and Organizer Below 	xSWD10-1530	15	30	20¾		
	xSWD10-1536	15	36	20¾		
	xSWD10-1542	15	42	20¾		
	xSWD11-1530	15	30	32¾	1 adjustable shelf	
	xSWD11-1536	15	36	32¾	1 adjustable shelf	
	xSWD11-1542	15	42	32¾	1 adjustable shelf	
	1 bay, 2 hinged doors Please specify Wall Mount or Spanner Cabinet.					
	Wall Mount/Spanner Storage with Doors and Organizer Below 	xSWD20-1548	15	48	20¾	
		xSWD20-1554	15	54	20¾	
xSWD20-1560		15	60	20¾		
xSWD20-1566		15	66	20¾		
xSWD20-1572		15	72	20¾		
xSWD20-1578		15	78	20¾		
xSWD21-1548		15	48	32¾	1 adjustable shelf each bay	
xSWD21-1554		15	54	32¾	1 adjustable shelf each bay	
xSWD21-1560		15	60	32¾	1 adjustable shelf each bay	
xSWD21-1566		15	66	32¾	1 adjustable shelf each bay	
xSWD21-1572		15	72	32¾	1 adjustable shelf each bay	
xSWD21-1578		15	78	32¾	1 adjustable shelf each bay	
2 bay, 4 hinged doors Please specify Wall Mount or Spanner Cabinet.						
Wall Mount/Spanner Storage with Doors and Organizer Below 		_SWD30-1584	15	84	20¾	
		_SWD30-1590	15	90	20¾	
	_SWD30-1596	15	96	20¾		
	_SWD31-1584	15	84	32¾	1 adjustable shelf each bay	
	_SWD31-1590	15	90	32¾	1 adjustable shelf each bay	
	_SWD31-1596	15	96	32¾	1 adjustable shelf each bay	
	3 bay, 6 hinged doors Please specify Wall Mount or Spanner Cabinet.					

(note: all units on this page have unfinished backs)
 (see page 60-61 for detailed top trim)

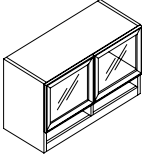
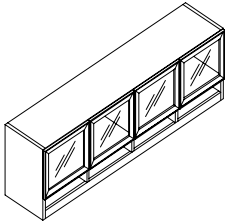
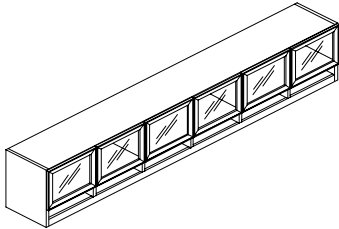
Description	Model Number	Overall Dimensions (in.)			Notes	
		Depth	Width	Height		
Wall Mount/Spanner Storage with Organizer Below 	xSWD100A-1530	15	30	20 ³ / ₄		
	xSWD100A-1536	15	36	20 ³ / ₄		
	xSWD100A-1542	15	42	20 ³ / ₄		
	xSWD110A-1530	15	30	32 ³ / ₄	1 adjustable shelf	
	xSWD110A-1536	15	36	32 ³ / ₄	1 adjustable shelf	
	xSWD110A-1542	15	42	32 ³ / ₄	1 adjustable shelf	
	1 bay					
	2 metal framed frosted glass doors	Please specify Wall Mount or Spanner Cabinet.				
Wall Mount/Spanner Storage with Organizer Below 	xSWD200A-1548	15	48	20 ³ / ₄		
	xSWD200A-1554	15	54	20 ³ / ₄		
	xSWD200A-1560	15	60	20 ³ / ₄		
	xSWD200A-1566	15	66	20 ³ / ₄		
	xSWD200A-1572	15	72	20 ³ / ₄		
	xSWD200A-1578	15	78	20 ³ / ₄		
	xSWD210A-1548	15	48	32 ³ / ₄	1 adjustable shelf each bay	
	xSWD210A-1554	15	54	32 ³ / ₄	1 adjustable shelf each bay	
	xSWD210A-1560	15	60	32 ³ / ₄	1 adjustable shelf each bay	
	xSWD210A-1566	15	66	32 ³ / ₄	1 adjustable shelf each bay	
	xSWD210A-1572	15	72	32 ³ / ₄	1 adjustable shelf each bay	
	xSWD210A-1578	15	78	32 ³ / ₄	1 adjustable shelf each bay	
	2 bay					
	4 metal framed frosted glass doors	Please specify Wall Mount or Spanner Cabinet.				
	Wall Mount/Spanner Storage with Organizer Below 	xSWD300A-1584	15	84	20 ³ / ₄	
		xSWD300A-1590	15	90	20 ³ / ₄	
		xSWD300A-1596	15	96	20 ³ / ₄	
xSWD310A-1584		15	84	32 ³ / ₄	1 adjustable shelf each bay	
xSWD310A-1590		15	90	32 ³ / ₄	1 adjustable shelf each bay	
xSWD310A-1596		15	96	32 ³ / ₄	1 adjustable shelf each bay	
3 bay						
6 metal framed frosted glass doors		Please specify Wall Mount or Spanner Cabinet.				
				(note: all units on this page have unfinished backs) (see page 60-61 for detailed top trim)		

Description	Model Number	Overall Dimensions (in.)			Notes
		Depth	Width	Height	
Wall Mount/Spanner Storage with Doors and Organizer Below	xSWD100F-1530	15	30	20¾	
	xSWD100F-1536	15	36	20¾	
	xSWD100F-1542	15	42	20¾	

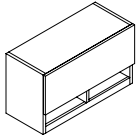

1 bay, 1 flipper door

Please specify Wall Mount or Spanner Cabinet.

Wall Mount/Spanner Storage with Doors and Organizer Below	xSWD200F-1548	15	48	20¾	
	xSWD200F-1554	15	54	20¾	
	xSWD200F-1560	15	60	20¾	
	xSWD200F-1566	15	66	20¾	
	xSWD200F-1572	15	72	20¾	
	xSWD200F-1578	15	78	20¾	

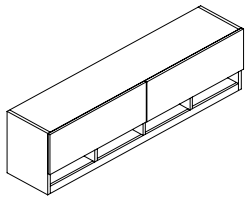

2 bay, 2 flipper doors

Please specify Wall Mount or Spanner Cabinet.

Wall Mount/Spanner Storage with Doors and Organizer Below	xSWD300F-1584	15	84	20¾	
	xSWD300F-1590	15	90	20¾	
	xSWD300F-1596	15	96	20¾	

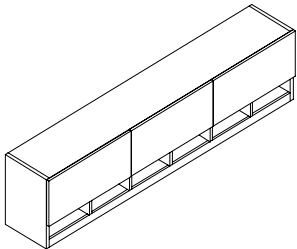

3 bay, 3 flipper doors

Please specify Wall Mount or Spanner Cabinet.

(note: all units on this page have unfinished backs)
(see page 60-61 for detailed top trim)

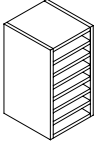
Description	Model Number	Overall Dimensions (in.)			Notes
		Depth	Width	Height	
	xSPS-1211	12¼	11	20	6-9½" w fixed shelves
	xSPS-1216	12¼	15¾	20	6-9½" w fixed shelves
	xSPS-1219	12¼	18¾	20	6-9½" w fixed shelves

Open with horizontal dividers

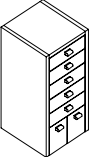

	xSPI-1211	12¼	11	20	6-9½" w fixed shelves 2-4" w drawers
	xSPI-1216	12¼	15¾	20	6-9½" w fixed shelves 2-4" w drawers
	xSPI-1219	12¼	18¾	20	6-9½" w fixed shelves 2-4" w drawers

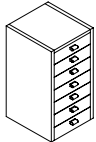
Combination open and 1 drawer

	xSPK-1211	12¼	11	20	7-8½" w drawers
	xSPK-1216	12¼	15¾	20	7-8½" w drawers
	xSPK-1219	12¼	18¾	20	7-8½" w drawers

All flat drawers

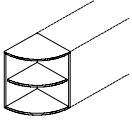
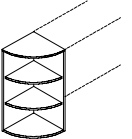
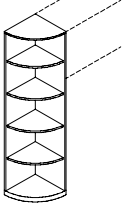
(note: all units on this page have unfinished backs)

Description	Model Number	Overall Dimensions (in.)			Notes
		Depth	Width	Height	
Bend Shelving for Wall Mount Storage 	xSEW100L-1414	14¼	14¼	20¾	bottom shelf only
	xSEW110L-1414	14¼	14¼	32¾	bottom shelf plus 1 fixed shelf
	xWCF1A-1515	15	15	1½	top cap with edge profile
Specify Left or Right	(Left indicated)				back painted black
Bend Shelving for High-Rise Applications 	xSET120L-1414	14¼	14¼	41¼	bottom shelf plus 2 fixed shelves
	xSET130L-1414	14¼	14¼	53¼	bottom shelf plus 3 fixed shelves
	xWCF1A-1515	15	15	1½	top cap with edge profile
Specify Left or Right	(Left indicated)				back painted black
Bend Shelving for High-Rise Applications 	xSE0140L-1515	15	15	70½	2¾ base plus 4 fixed shelves
	xSE0150L-1515	15	15	82½	2¾ base plus 5 fixed shelves
	xSE0140L-2515	25	15	70½	2¾ base plus 4 fixed shelves
	xSE0150L-2515	25	15	82½	2¾ base plus 5 fixed shelves
	xWCF1A-1515	15	15	1½	top cap with edge profile
	xWCF1A-2515	25	15	1½	top cap with edge profile
Specify Left or Right	(Left indicated)				back painted black
Bend Shelving for High-Rise Applications - Desktop 	xSPE110-1212	12¼	12¼	20	1 fixed shelf
	xSPE160-1212	12¼	12¼	20	6 fixed sorter shelves
Unhanded					finished 3 sides and top

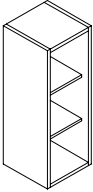
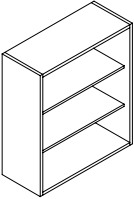
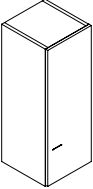
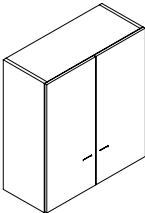
Description	Model Number	Overall Dimensions (in.)			Notes
		Depth	Width	Height	
	xSUS12-1415	14¼	15	41¼	2 adjustable shelves
	xSUS12-1418	14¼	18	41¼	2 adjustable shelves
	xSUS13-1415	14¼	15	53¼	3 adjustable shelves
	xSUS13-1418	14¼	18	53¼	3 adjustable shelves
	xSUS12-1430	14¼	30	41¼	2 adjustable shelves
	xSUS12-1436	14¼	36	41¼	2 adjustable shelves
	xSUS13-1430	14¼	30	53¼	3 adjustable shelves
	xSUS13-1436	14¼	36	53¼	3 adjustable shelves
	xSUT12-1515- R	15	15	41¼	2 adjustable shelves
	xSUT12-1518- R	15	18	41¼	2 adjustable shelves
	xSUT13-1515- R	15	15	53¼	3 adjustable shelves
	xSUT13-1518- R	15	18	53¼	3 adjustable shelves
Specify L eft or R ight hinged door (right shown)					
	xSUT12-1530	15	30	41¼	2 adjustable shelves
	xSUT12-1536	15	36	41¼	2 adjustable shelves
	xSUT13-1530	15	30	53¼	3 adjustable shelves
	xSUT13-1536	15	36	53¼	3 adjustable shelves

(note: all units on this page have unfinished backs)

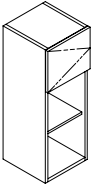
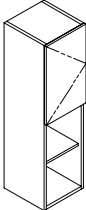
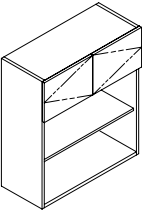
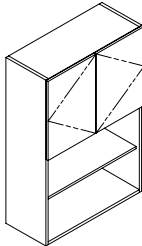
Description	Model Number	Overall Dimensions (in.)			Notes
		Depth	Width	Height	
Tower Anchor with Door 	xSUP101-1515-R	15	15	41¼	1 adjustable shelf below door
	xSUP101-1518-R	15	18	41¼	1 adjustable shelf below door
Specify Left or Right hinged door (right shown)					(upper doors align with upper storage)
Tower Anchor with Door 	xSUP111-1515-R	15	15	53¼	1 adjustable shelf behind door and 1 below
	xSUP111-1518-R	15	18	53¼	1 adjustable shelf behind door and 1 below
Specify Left or Right hinged door (right shown)					(upper doors align with upper storage)
Tower Anchor with Doors 	xSUP101-1530	15	30	41¼	1 adjustable shelf below door
	xSUP101-1536	15	36	41¼	1 adjustable shelf below door
					(upper doors align with upper storage)
Tower Anchor with Doors 	xSUP111-1530	15	30	53¼	1 adjustable shelf behind door and 1 below
	xSUP111-1536	15	36	53¼	1 adjustable shelf behind door and 1 below
(note: all units on this page have unfinished backs)					(upper doors align with upper storage)

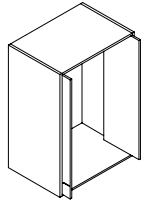
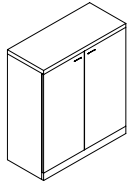
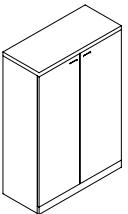
Description	Model Number	Overall Dimensions (in.)			Notes
		Depth	Width	Height	
Upper Storage Video Cabinet with Full Height Retractable Doors 	xSUT10R-203041	20	30	41¼	Unit to sit on credenza
	xSUT10R-203641	20	36	41¼	
	xSUT10R-253041	25	30	41¼	
	xSUT10R-253641	25	36	41¼	
	xSUT10R-203053	20	30	53¼	
	xSUT10R-203653	20	36	53¼	
	xSUT10R-253053	25	30	53¼	
	xSUT10R-253653	25	36	53¼	
Hinged Door Storage 	xSHU12-1630	16	30⅞	42¾	Free standing unit
	xSHU12-1636	16	36⅞	42¾	
	xSHU12-2030	20	30⅞	42¾	
	xSHU12-2036	20	36⅞	42¾	
	xSHU12-2430	24	30⅞	42¾	
	xSHU12-2436	24	36⅞	42¾	
Hinged Door Storage 	xSHU13-1630	16	30⅞	55	Free standing unit (note: all units on this page have unfinished backs)
	xSHU13-1636	16	36⅞	55	
	xSHU13-2030	20	30⅞	55	
	xSHU13-2036	20	36⅞	55	
	xSHU13-2430	24	30⅞	55	
	xSHU13-2436	24	36⅞	55	
2 adjustable shelves Includes full 1½" overlay top					
3 adjustable shelves Includes full 1½" overlay top					

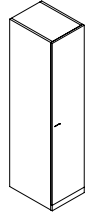
Description	Model Number	Overall Dimensions (in.)			Notes
		Depth	Width	Height	
 Hinged Door Storage	xSHU14-1516- R	15	15¾	70½	
	xSHU14-1519- R	15	18¾	70½	
	xSHU14-2516- R	25	15¾	70½	
	xSHU14-2519- R	25	18¾	70½	

4 adjustable shelves Specify **Left** or **Right** hinged door (right shown)

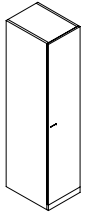
 Hinged Door Storage	xSHU15-1516- R	15	15¾	82½	
	xSHU15-1519- R	15	18¾	82½	
	xSHU15-2516- R	25	15¾	82½	
	xSHU15-2519- R	25	18¾	82½	

5 adjustable shelves Specify **Left** or **Right** hinged door (right shown)

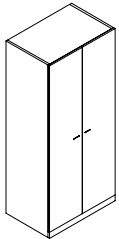
 Hinged Door Storage	xSHU14-2530	25	30	70½	4 adjustable shelves
	xSHU14-2536	25	36	70½	4 adjustable shelves
	xSHU15-2530	25	30	82½	5 adjustable shelves
	xSHU15-2536	25	36	82½	5 adjustable shelves

(note: all units on this page have unfinished backs)

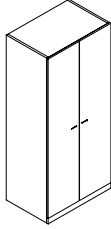
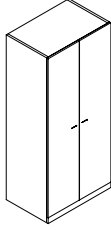
Description	Model Number	Overall Dimensions (in.)			Notes	
		Depth	Width	Height		
	xSCU11-2516- R	25	15¾	70½	coat bar and one shelf inside	
	xSCU11-2519- R	25	18¾	70½	coat bar and one shelf inside	
	xSCU12-2516- R	25	15¾	82½	coat bar and two shelves inside	
	xSCU12-2519- R	25	18¾	82½	coat bar and two shelves inside	
	Specify Left or Right hinged door (right shown)					
		xSDU24-2530	25	30	70½	4 adjustable shelves on right half coat rod on left half
xSDU24-2536		25	36	70½	4 adjustable shelves on right half coat rod on left half	
xSDU25-2530		25	30	82½	5 adjustable shelves on right half coat rod on left	
xSDU25-2536		25	36	82½	5 adjustable shelves on right half coat rod on left	
	xSCU11-2530	25	30	70½	full width coat rod and hat shelf inside	
	xSCU11-2536	25	36	70½	full width coat rod and hat shelf inside	
	xSCU12-2530	25	30	82½	full width coat rod and two shelves inside	
	xSCU12-2536	25	36	82½	full width coat rod and two shelves inside	

(note: all units on this page have unfinished backs)

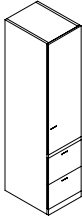
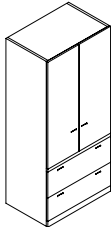
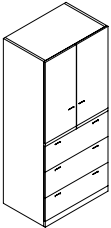
Description	Model Number	Overall Dimensions (in.)			Notes
		Depth	Width	Height	
Combination File/Storage 	xSSU122-2519- R	25	18¾	70½	2 adjustable shelves above 2 legal width file drawers below
	xSSU132-2519- R	25	18¾	82½	3 adjustable shelves above 2 legal width file drawers below
Specify Left or Right hinged door (right shown)					
Combination File/Storage 	xSSU122-2530	25	30	70½	2 adjustable shelves above 2- 30" w lateral file drawers below
	xSSU122-2536	25	36	70½	2 adjustable shelves above 2- 36" w lateral file drawers below
	xSSU132-2530	25	30	82½	3 adjustable shelves above 2- 30" w lateral file drawers below
	xSSU132-2536	25	36	82½	3 adjustable shelves above 2- 36" w lateral file drawers below
Combination File/Storage 	xSSU113-2530	25	30	70½	1 adjustable shelf above 3- 30" w lateral file drawers below
	xSSU113-2536	25	36	70½	1 adjustable shelf above 3- 36" w lateral file drawers below
	xSSU123-2530	25	30	82½	2 adjustable shelves above 3- 30" w lateral file drawers below
	xSSU123-2536	25	36	82½	2 adjustable shelves above 3- 36" w lateral file drawers below

(note: all units on this page have unfinished backs)

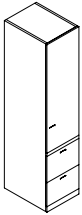
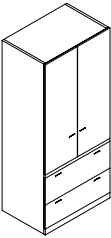
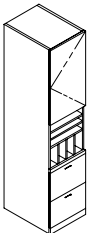
Description	Model Number	Overall Dimensions (in.)			Notes
		Depth	Width	Height	
Combination File/Wardrobe	xSQU102-2519-R	25	18¾	70½	coat bar above, 2 legal width files below
	xSQU112-2519-R	25	18¾	82½	coat bar & shelf above, 2 legal width files below
					
Specify Left or Right hinged door (right shown)					
Combination File/Wardrobe	xSQU102-2530	25	30	70½	coat bar above, 2 lateral files below
	xSQU102-2536	25	36	70½	coat bar above, 2 lateral files below
	xSQU112-2530	25	30	82½	coat bar & shelf above, 2 lateral files below
	xSQU112-2536	25	36	82½	coat bar & shelf above, 2 lateral files below
					
Combination File/Storage/Sorter	xSYU102-2516-L	25	15¾	71	
	xSYU102-2519-L	25	18¾	71	
	xSYU112-2516-L	25	15¾	83	1 adjustable shelf inside cabinet
	xSYU112-2519-L	25	18¾	83	1 adjustable shelf inside cabinet
					
2 legal width lateral file drawers below					
Specify Left or Right hinged door (left shown)					
(note: all units on this page have unfinished backs)					

Description	Model Number	Overall Dimensions (in.)			Notes
		Depth	Width	Height	
Video Cabinet - Hinged	xSVU121-2530	25	30	70½	2 adjustable shelves above, 1 below
Doors over Hinged Doors	xSVU121-2536	25	36	70½	2 adjustable shelves above, 1 below
	xSVU131-2530	25	30	82½	3 adjustable shelves above, 1 below
	xSVU131-2536	25	36	82½	3 adjustable shelves above, 1 below

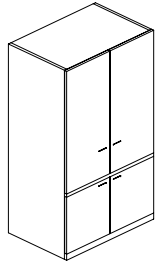

Video Cabinet - Upper Retractable	xVHR01-253071-0-VS2	25	30	70½	1 adjustable shelf below
Doors over Hinged Doors	xVHR01-253671-0-VS2	25	36	70½	1 adjustable shelf below
	xVHR01-253083-0-VS2	25	30	82½	1 adjustable shelf below
	xVHR01-253683-0-VS2	25	36	82½	1 adjustable shelf below

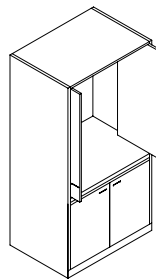

includes 2 ventilation slots

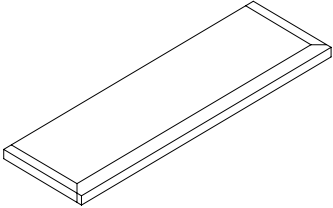
Description	Model Number	Overall Dimensions (in.)			Notes
		Depth	Width	Height	
Top Cap 	_WCF1-1530	15	30	1½	for unit without doors
	_WCF1-1536	15	36	1½	for unit without doors
	_WCF1-1542	15	42	1½	for unit without doors
	_WCF1-1548	15	48	1½	for unit without doors
	_WCF1-1554	15	54	1½	for unit without doors
	_WCF1-1560	15	60	1½	for unit without doors
	_WCF1-1566	15	66	1½	for unit without doors
	_WCF1-1572	15	72	1½	for unit without doors
	_WCF1-1578	15	78	1½	for unit without doors
	_WCF1-1584	15	84	1½	for unit without doors
	_WCF1-1590	15	90	1½	for unit without doors
	_WCF1-1596	15	96	1½	for unit without doors
	_WCF1-15108	15	108	1½	for unit without doors
	_WCF1-1615	16	15	1½	for unit with doors
	_WCF1-1616	16	16	1½	for unit with doors
	_WCF1-1618	16	18	1½	for unit with doors
	_WCF1-1619	16	19	1½	for unit with doors
	_WCF1-1630	16	30	1½	for unit with doors
	_WCF1-1636	16	36	1½	for unit with doors
	_WCF1-1642	16	42	1½	for unit with doors
	_WCF1-1648	16	48	1½	for unit with doors
	_WCF1-1654	16	54	1½	for unit with doors
	_WCF1-1660	16	60	1½	for unit with doors
	_WCF1-1666	16	66	1½	for unit with doors
	_WCF1-1672	16	72	1½	for unit with doors
	_WCF1-1678	16	78	1½	for unit with doors
	_WCF1-1684	16	84	1½	for unit with doors
	_WCF1-1690	16	90	1½	for unit with doors
	_WCF1-1696	16	96	1½	for unit with doors
	_WCF1-16108	16	108	1½	for unit with doors
	_WCF1-2116	21	16	1½	for unit with doors
	_WCF1-2119	21	19	1½	for unit with doors
	_WCF1-2130	21	30	1½	for unit with doors
	_WCF1-2136	21	36	1½	for unit with doors
	Used to add detail to upper storage and anchor units without full overlay tops	_WCF1-2616	26	16	1½
	_WCF1-2619	26	19	1½	for unit with doors
	_WCF1-2630	26	30	1½	for unit with doors
Profile front edge only	_WCF1-2636	26	36	1½	for unit with doors

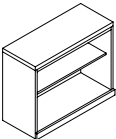
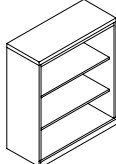
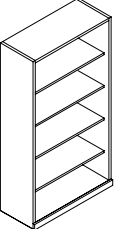
Description	Model Number	Overall Dimensions (in.)			Notes
		Depth	Width	Height	
Bookcase 	xSBU11-153028	15	30 $\frac{1}{8}$	27 $\frac{3}{4}$	matches pedestals, 1 shelf at 10 $\frac{5}{8}$ " and one at 11 $\frac{7}{8}$ " clear height *
	xSBU11-153628	15	36 $\frac{1}{8}$	27 $\frac{3}{4}$	
	_SBU11-153029	15 $\frac{1}{8}$	30 $\frac{1}{8}$	29 $\frac{1}{4}$	both shelf openings at 11 $\frac{7}{8}$ " clear **
	_SBU11-153629	15 $\frac{1}{8}$	36 $\frac{1}{8}$	29 $\frac{1}{4}$	both shelf openings at 11 $\frac{7}{8}$ " clear **
					*unit has unfinished top ** unit has full 1 $\frac{1}{2}$ " detailed overlay top
Bookcase 	_SBU12-153043	15 $\frac{1}{8}$	30 $\frac{1}{8}$	42 $\frac{3}{4}$	2 adjustable shelves
	_SBU12-153643	15 $\frac{1}{8}$	36 $\frac{1}{8}$	42 $\frac{3}{4}$	2 adjustable shelves
	_SBU13-153055	15 $\frac{1}{8}$	30 $\frac{1}{8}$	55	3 adjustable shelves
	_SBU13-153655	15 $\frac{1}{8}$	36 $\frac{1}{8}$	55	3 adjustable shelves
Includes full 1 $\frac{1}{2}$ " overlay top					
Bookcase 	xSBU14-1530	15	30 $\frac{1}{8}$	70 $\frac{1}{2}$	4 adjustable shelves
	xSBU14-1536	15	36 $\frac{1}{8}$	70 $\frac{1}{2}$	4 adjustable shelves
No overlay top					(See page 60 for top trim options.) (note: all units on this page have unfinished backs)

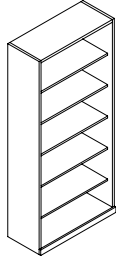
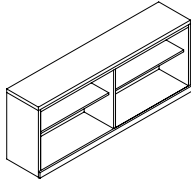
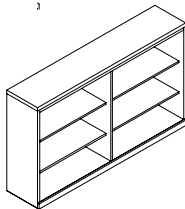
Description	Model Number	Overall Dimensions (in.)			Notes
		Depth	Width	Height	
Bookcase 	xSBU15-1530	15	30 $\frac{1}{8}$	82 $\frac{1}{2}$	5 adjustable shelves
	xSBU15-1536	15	36 $\frac{1}{8}$	82 $\frac{1}{2}$	5 adjustable shelves
No overlay top					
Bookcase 	xSBU21-156028	15 $\frac{1}{8}$	60 $\frac{1}{8}$	27 $\frac{3}{4}$	matches pedestals, one shelf at 10 $\frac{5}{8}$ " and one at 11 $\frac{7}{8}$ " clear height *
	xSBU21-157228	15 $\frac{1}{8}$	72 $\frac{1}{8}$	27 $\frac{3}{4}$	
	_SBU21-156029	15 $\frac{1}{8}$	60 $\frac{1}{8}$	29 $\frac{1}{4}$	both shelf openings at 11 $\frac{7}{8}$ " clear **
	_SBU21-157229	15 $\frac{1}{8}$	72 $\frac{1}{8}$	29 $\frac{1}{4}$	both shelf openings at 11 $\frac{7}{8}$ " clear **
					unit has unfinished top unit has full 1 $\frac{1}{2}$ " overlay top
1 adjustable shelf each bay					
Bookcase 	_SBU22-1560	15 $\frac{1}{8}$	60 $\frac{1}{8}$	42 $\frac{3}{4}$	
	_SBU22-1572	15 $\frac{1}{8}$	72 $\frac{1}{8}$	42 $\frac{3}{4}$	
					(note: all units on this page have unfinished backs)
2 adjustable shelves each bay Includes full 1 $\frac{1}{2}$ " overlay top					

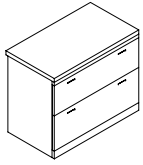
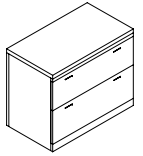
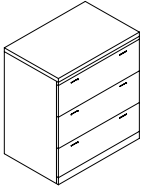
Description	Model Number	Overall Dimensions (in.)			Notes
		Depth	Width	Height	
Freestanding Storage 	_C000N-2030-E	20	30 ¹ / ₈	29 ¹ / ₄	
	_C000N-2036-F	20	36 ¹ / ₈	29 ¹ / ₄	
	_C000N-2430-E	24	30 ¹ / ₈	29 ¹ / ₄	
	_C000N-2436-F	24	36 ¹ / ₈	29 ¹ / ₄	
Unfinished back Includes full 1 ¹ / ₂ " overlay top					
Freestanding Storage 	_C000L-2030-E	20	30 ¹ / ₈	29 ¹ / ₄	
	_C000L-2036-F	20	36 ¹ / ₈	29 ¹ / ₄	
	_C000L-2430-E	24	30 ¹ / ₈	29 ¹ / ₄	
	_C000L-2436-F	24	36 ¹ / ₈	29 ¹ / ₄	
Full finished back Includes full 1 ¹ / ₂ " overlay top					
3 Drawer Lateral File 	_SFU103-2030	20	30 ¹ / ₈	42 ³ / ₄	
	_SFU103-2036	20	36 ¹ / ₈	42 ³ / ₄	
Unfinished back Includes full 1 ¹ / ₂ " overlay top					

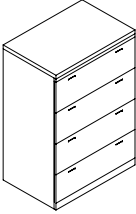
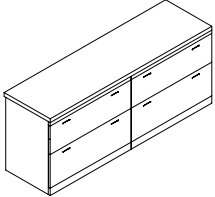
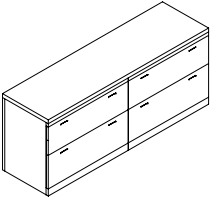
Description	Model Number	Overall Dimensions (in.)			Notes
		Depth	Width	Height	
4 Drawer Lateral File	_SFU104-2030	20	30 $\frac{1}{8}$	55	
	_SFU104-2036	20	36 $\frac{1}{8}$	55	
					
Unfinished back Includes full 1 $\frac{1}{2}$ " detailed overlay top					
Freestanding Storage Credenza	_C000N-2060-EE	20	60 $\frac{1}{8}$	29 $\frac{1}{4}$	
	_C000N-2072-FF	20	72 $\frac{1}{8}$	29 $\frac{1}{4}$	
	_C000N-2460-EE	24	60 $\frac{1}{8}$	29 $\frac{1}{4}$	
	_C000N-2472-FF	24	72 $\frac{1}{8}$	29 $\frac{1}{4}$	
					
Unfinished back Includes full 1 $\frac{1}{2}$ " overlay top					
Freestanding Storage Credenza	_C000L-2060-EE	20	60 $\frac{1}{8}$	29 $\frac{1}{4}$	
	_C000L-2072-FF	20	72 $\frac{1}{8}$	29 $\frac{1}{4}$	
	_C000L-2460-EE	24	60 $\frac{1}{8}$	29 $\frac{1}{4}$	
	_C000L-2472-FF	24	72 $\frac{1}{8}$	29 $\frac{1}{4}$	
					
Full finished back Includes full 1 $\frac{1}{2}$ " overlay top					

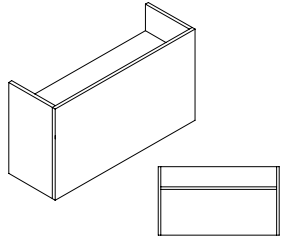
Description	Model Number	Overall Dimensions (in.)			Notes
		Depth	Width	Height	
Gallery Desk Shell 	xD0R-2460-0-GL2	24	60	41¼	
	xD0R-2466-0-GL2	24	66	41¼	
	xD0R-2472-0-GL2	24	72	41¼	
	xD0R-2478-0-GL2	24	78	41¼	
	xD0R-2484-0-GL2	24	84	41¼	
	xD0R-2490-0-GL2	24	90	41¼	
	xD0R-2496-0-GL2	24	96	41¼	
	xD0R-3060-0-GL2	30	60	41¼	
	xD0R-3066-0-GL2	30	66	41¼	
	xD0R-3072-0-GL2	30	72	41¼	
	xD0R-3078-0-GL2	30	78	41¼	
	xD0R-3084-0-GL2	30	84	41¼	
	xD0R-3090-0-GL2	30	90	41¼	
	xD0R-3096-0-GL2	30	96	41¼	

Includes 2 grommets

(note: no profile detail available)

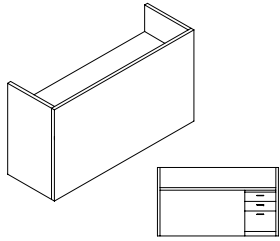
Gallery Desk w/ Single Pedestal 	xD0R-2466-AR-GL2	24	66	41¼	letter width b/b/f pedestal
	xD0R-2472-CR-GL2	24	72	41¼	legal width b/b/f pedestal
	xD0R-2478-CR-GL2	24	78	41¼	legal width b/b/f pedestal
	xD0R-2484-CR-GL2	24	84	41¼	legal width b/b/f pedestal
	xD0R-2490-CR-GL2	24	90	41¼	legal width b/b/f pedestal
	xD0R-2496-CR-GL2	24	96	41¼	legal width b/b/f pedestal
	xD0R-3066-AR-GL2	30	66	41¼	letter width b/b/f pedestal
	xD0R-3072-CR-GL2	30	72	41¼	legal width b/b/f pedestal
	xD0R-3078-CR-GL2	30	78	41¼	legal width b/b/f pedestal
	xD0R-3084-CR-GL2	30	84	41¼	legal width b/b/f pedestal
	xD0R-3090-CR-GL2	30	90	41¼	legal width b/b/f pedestal
	xD0R-3096-CR-GL2	30	96	41¼	legal width b/b/f pedestal

Includes 2 grommets

Specify **L**eft or **R**ight (seated)

(**R**ight indicated)

(note: no profile detail available)

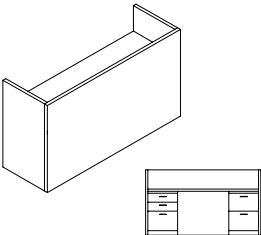
Description	Model Number	Overall Dimensions (in.)			Notes
		Depth	Width	Height	
	xD0R-2466-AKB-GL2	24	66	41¼	letter width b/b/f and f/f pedestals
	xD0R-2472-CKD-GL2	24	72	41¼	legal width b/b/f and f/f pedestals
	xD0R-2478-CKD-GL2	24	78	41¼	legal width b/b/f and f/f pedestals
	xD0R-2484-CKD-GL2	24	84	41¼	legal width b/b/f and f/f pedestals
	xD0R-2490-CKD-GL2	24	90	41¼	legal width b/b/f and f/f pedestals
	xD0R-2496-CKD-GL2	24	96	41¼	legal width b/b/f and f/f pedestals
	xD0R-3066-AKB-GL2	30	66	41¼	letter width b/b/f and f/f pedestals
	xD0R-3072-CKD-GL2	30	72	41¼	legal width b/b/f and f/f pedestals
	xD0R-3078-CKD-GL2	30	78	41¼	legal width b/b/f and f/f pedestals
	xD0R-3084-CKD-GL2	30	84	41¼	legal width b/b/f and f/f pedestals
	xD0R-3090-CKD-GL2	30	90	41¼	legal width b/b/f and f/f pedestals
	xD0R-3096-CKD-GL2	30	96	41¼	legal width b/b/f and f/f pedestals

Includes 2 grommets

(note: no profile detail available)

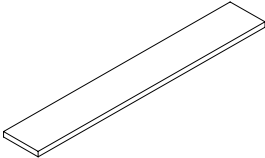
	_WA11-1166	11	66⅞	1½
	_WA11-1172	11	72⅞	1½
	_WA11-1178	11	78⅞	1½
	_WA11-1184	11	84⅞	1½
	_WA11-1190	11	90⅞	1½
	_WA11-1196	11	96⅞	1½
	_WA11-11102	11	102⅞	1½
	_WA11-11108	11	108⅞	1½

Detail approach side only

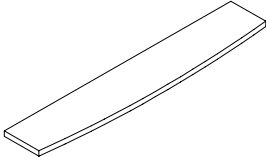
	_WA11F-1366	13	66⅞	1½
	_WA11F-1472	13½	72⅞	1½
	_WA11F-1478	14	78⅞	1½
	_WA11F-1584	14½	84⅞	1½
	_WA11F-1590	15	90⅞	1½
	_WA11F-1696	15½	96⅞	1½
	_WA11F-16102	16	102⅞	1½
	_WA11F-17108	16½	108⅞	1½

Detail approach side only

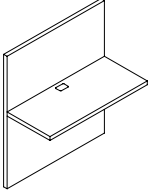
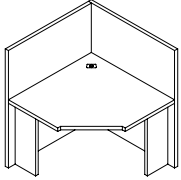
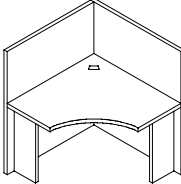
Description	Model Number	Overall Dimensions (in.)			Notes	
		Depth	Width	Height		
	xBOR-2036-0-GL1	20	36	41¼		
	xBOR-2042-0-GL1	20	42	41¼		
	xBOR-2048-0-GL1	20	48	41¼		
	xBOR-2054-0-GL1	20	54	41¼		
	xBOR-2436-0-GL1	24	36	41¼		
	xBOR-2442-0-GL1	24	42	41¼		
	xBOR-2448-0-GL1	24	48	41¼		
	xBOR-2454-0-GL1	24	54	41¼		
	xBOR-3036-0-GL1	30	36	41¼		
	xBOR-3042-0-GL1	30	42	41¼		
	xBOR-3048-0-GL1	30	48	41¼		
	xBOR-3054-0-GL1	30	54	41¼		
	Includes 1 grommet - center					(note: no profile detail available)
	 <p>Seated Diagonal</p>  <p>Seated Radius</p>	xBCRA-3636-0-GL1	36	36	41¼	connects to 20" both sides
xBCRB-3636-0-GL1		36	36	41¼	connects to 24" both sides	
xBCRD-3636-0-GL1		36	36	41¼	connects to 20" on left and 24" on right	
xBCRE-3636-0-GL1		36	36	41¼	connects to 24" on left and 20" on right	
xBCRA-4242-0-GL1		42	42	41¼	connects to 20" both sides	
xBCRB-4242-0-GL1		42	42	41¼	connects to 24" both sides	
xBCRC-4242-0-GL1		42	42	41¼	connects to 30" both sides	
xBCRD-4242-0-GL1		42	42	41¼	connects to 20" on left and 24" on right	
xBCRE-4242-0-GL1		42	42	41¼	connects to 24" on left and 20" on right	
xBCRA0D-3636-0-GL1		36	36	41¼	connects to 20" both sides	
xBCRB0D-3636-0-GL1		36	36	41¼	connects to 24" both sides	
xBCRD0D-3636-0-GL1		36	36	41¼	connects to 20" on left and 24" on right	
xBCRE0D-3636-0-GL1		36	36	41¼	connects to 24" on left and 20" on right	
xBCRA0D-4242-0-GL1		42	42	41¼	connects to 20" both sides	
xBCRB0D-4242-0-GL1	42	42	41¼	connects to 24" both sides		
xBCRC0D-4242-0-GL1	42	42	41¼	connects to 30" both sides		
xBCRD0D-4242-0-GL1	42	42	41¼	connects to 20" on left and 24" on right		
xBCRE0D-4242-0-GL1	42	42	41¼	connects to 24" on left and 20" on right		
Includes 1 grommet - center	see page 15 for diagonal or radius dimension				unit to ship knockdown with removable worksurface (note: no profile detail available)	

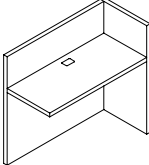
Description	Model Number	Overall Dimensions (in.)			Notes
		Depth	Width	Height	
 Gallery Desk Return Shell	xR0R-2036- R -GL1	20	36	41¼	
	xR0R-2042- R -GL1	20	42	41¼	
	xR0R-2048- R -GL1	20	48	41¼	
	xR0R-2054- R -GL1	20	54	41¼	
	xR0R-2060- R -GL1	20	60	41¼	
	xR0R-2436- R -GL1	24	36	41¼	
	xR0R-2442- R -GL1	24	42	41¼	
	xR0R-2448- R -GL1	24	48	41¼	
	xR0R-2454- R -GL1	24	54	41¼	
	xR0R-2460- R -GL1	24	60	41¼	
	xR0R-3042- R-0 -GL1	30	42	41¼	
	xR0R-3048- R-0 -GL1	30	48	41¼	
	xR0R-3054- R-0 -GL1	30	54	41¼	
	xR0R-3060- R-0 -GL1	30	60	41¼	

Includes 1 grommet - center of kneespace

Specify **L** or **R** (seated) (**R** indicated)

(note: no profile detail available)

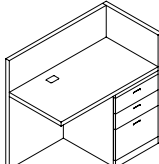
 Gallery Desk Return w/ Single Pedestal	xR0R-2042- AR -GL1	20	42	41¼	letter width b/b/f pedestal
	xR0R-2048- CR -GL1	20	48	41¼	legal width b/b/f pedestal
	xR0R-2054- CR -GL1	20	54	41¼	legal width b/b/f pedestal
	xR0R-2060- CR -GL1	20	60	41¼	legal width b/b/f pedestal
	xR0R-2442- AR -GL1	24	42	41¼	letter width b/b/f pedestal
	xR0R-2448- CR -GL1	24	48	41¼	legal width b/b/f pedestal
	xR0R-2454- CR -GL1	24	54	41¼	legal width b/b/f pedestal
	xR0R-2460- CR -GL1	24	60	41¼	legal width b/b/f pedestal
	xR0R-3042- AR -GL1	30	42	41¼	letter width b/b/f pedestal
	xR0R-3048- CR -GL1	30	48	41¼	legal width b/b/f pedestal
	xR0R-3054- CR -GL1	30	54	41¼	legal width b/b/f pedestal
	xR0R-3060- CR -GL1	30	60	41¼	legal width b/b/f pedestal

Includes 1 grommet - center of kneespace

Specify **L** or **R** (seated) (**R** indicated)

(note: no profile detail available)

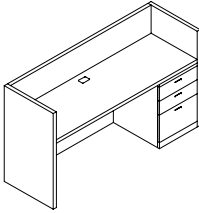
Description	Model Number	Overall Dimensions (in.)			Notes
		Depth	Width	Height	
Gallery Desk Credenza 	xC0R-2466-AR-GL1	24	66	41¼	letter width b/b/f pedestal
	xC0R-2472-CR-GL1	24	72	41¼	legal width b/b/f pedestal
	xC0R-2478-CR-GL1	24	78	41¼	legal width b/b/f pedestal
	xC0R-2484-CR-GL1	24	84	41¼	legal width b/b/f pedestal
	xC0R-2490-CR-GL1	24	90	41¼	legal width b/b/f pedestal
	xC0R-2496-CR-GL1	24	96	41¼	legal width b/b/f pedestal
	xC0R-3066-AR-GL1	30	66	41¼	letter width b/b/f pedestal
	xC0R-3072-CR-GL1	30	72	41¼	legal width b/b/f pedestal
	xC0R-3078-CR-GL1	30	78	41¼	legal width b/b/f pedestal
	xC0R-3084-CR-GL1	30	84	41¼	legal width b/b/f pedestal
	xC0R-3090-CR-GL1	30	90	41¼	legal width b/b/f pedestal
	xC0R-3096-CR-GL1	30	96	41¼	legal width b/b/f pedestal

Includes 1 grommet - center of kneespace

Legal width b/b/f pedestal

Specify **Left** or **Right** (seated)

(**Right** indicated)

(note: no profile detail available)

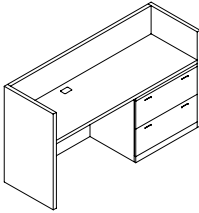
Gallery Desk Credenza 	xC0R-2466-ER-GL1	24	66	41¼	
	xC0R-2472-ER-GL1	24	72	41¼	
	xC0R-2478-ER-GL1	24	78	41¼	
	xC0R-2484-ER-GL1	24	84	41¼	
	xC0R-2490-ER-GL1	24	90	41¼	
	xC0R-2496-ER-GL1	24	96	41¼	
	xC0R-3066-ER-GL1	30	66	41¼	
	xC0R-3072-ER-GL1	30	72	41¼	
	xC0R-3078-ER-GL1	30	78	41¼	
	xC0R-3084-ER-GL1	30	84	41¼	
	xC0R-3090-ER-GL1	30	90	41¼	
	xC0R-3096-ER-GL1	30	96	41¼	

Includes 1 grommet - center of kneespace

Letter width lateral file pedestal

Specify **Left** or **Right** (seated)

(**Right** indicated)

(note: no profile detail available)

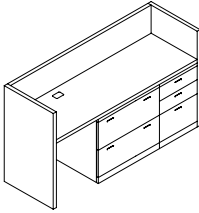
Description	Model Number	Overall Dimensions (in.)			Notes
		Depth	Width	Height	
	xCOR-2472-ECR-GL1	24	72	41¼	
	xCOR-2478-ECR-GL1	24	78	41¼	
	xCOR-2484-ECR-GL1	24	84	41¼	
	xCOR-2490-ECR-GL1	24	90	41¼	
	xCOR-2496-ECR-GL1	24	96	41¼	
	xCOR-3072-ECR-GL1	30	72	41¼	
	xCOR-3078-ECR-GL1	30	78	41¼	
	xCOR-3084-ECR-GL1	30	84	41¼	
	xCOR-3090-ECR-GL1	30	90	41¼	
	xCOR-3096-ECR-GL1	30	96	41¼	

Includes 1 grommet - center of kneespace

Letter width lateral file pedestal

Legal width b/b/f pedestal

Specify **Left** or **Right** (seated)

(Right indicated)

(note: no profile detail available)

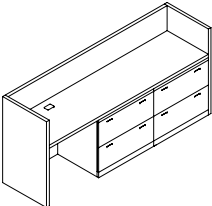
	xCOR-2490-EER-GL1	24	90	41¼	
	xCOR-2496-EER-GL1	24	96	41¼	
	xCOR-3090-EER-GL1	30	90	41¼	
	xCOR-3096-EER-GL1	30	96	41¼	

Includes 1 grommet - center of kneespace

2 letter width lateral file pedestals

Specify **Left** or **Right** (seated)

(Right indicated)

(note: no profile detail available)

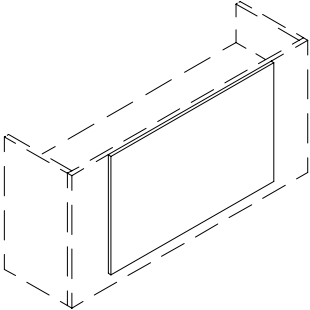
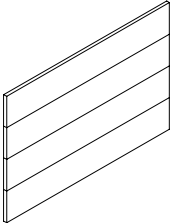
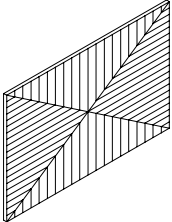
Description	Model Number	Overall Dimensions (in.)			Notes
		Depth	Width	Height	
Applied Feature Fronts for Gallery Desks					
I 	1WFI-15838	3/4	58	38	vertical grain cherry or maple
	1WFI-16438	3/4	64	38	
	1WFI-17038	3/4	70	38	
	1WFI-17638	3/4	76	38	
II 	1WFII-15838	3/4	58	38	vertical grain cherry or maple with black 1/4" x 1/4" horizontal reveals
	1WFII-16438	3/4	64	38	
	1WFII-17038	3/4	70	38	
	1WFII-17638	3/4	76	38	
III 	1WFIII-15838	3/4	58	38	reverse box pattern birdseye maple
	1WFIII-16438	3/4	64	38	
	1WFIII-17038	3/4	70	38	
	1WFIII-17638	3/4	76	38	

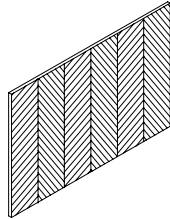
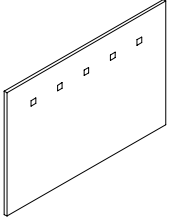
Description	Model Number	Overall Dimensions (in.)			Notes
		Depth	Width	Height	
IV 	1WFIV-15838	3/4	59	38	quartered figured sycamore or anigre
	1WFIV-16438	3/4	64	38	
	1WFIV-17038	3/4	70	38	
	1WFIV-17638	3/4	76	38	
V 	1WFV-15838	3/4	58	38	contrast square inlay options: options: * natural cherry in natural maple * natural maple in natural cherry * black in maple (any CCN standard finish) * black in cherry (any CCN standard finish)
	1WFV-16438	3/4	64	38	
	1WFV-17038	3/4	70	38	
	1WFV-17638	3/4	76	38	
<p>58 inch wide Feature Fronts recommended for use on 72 inch wide Gallery Desks 64 inch wide Feature Fronts recommended for use on 78 inch wide Gallery Desks 70 inch wide Feature Fronts recommended for use on 84 inch wide Gallery Desks 76 inch wide Feature Fronts recommended for use on 96 inch wide Gallery Desks</p>					

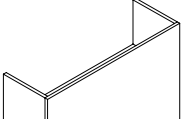
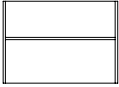
Description	Model Number	Overall Dimensions (in.)			Notes
		Depth	Width	Height	
Workstation Desk Shell  	xD0R-2460-0-GL2	24	60	50½	
	xD0R-2466-0-GL2	24	66	50½	
	xD0R-2472-0-GL2	24	72	50½	
	xD0R-2478-0-GL2	24	78	50½	
	xD0R-2484-0-GL2	24	84	50½	
	xD0R-2490-0-GL2	24	90	50½	
	xD0R-2496-0-GL2	24	96	50½	

Includes 2 grommets

(note: no profile detail available)

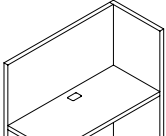
Workstation Return Shell 	xR0R-2436- R -GL1	24	36	50½	
	xR0R-2442- R -GL1	24	42	50½	
	xR0R-2448- R -GL1	24	48	50½	
	xR0R-2454- R -GL1	24	54	50½	
	xR0R-2460- R -GL1	24	60	50½	
	xR0R-2466- R -GL1	24	66	50½	
	xR0R-2472- R -GL1	24	72	50½	

Includes 1 grommet - center
Specify **L**eft or **R**ight (seated)

(**R**ight indicated)

(note: no profile detail available)

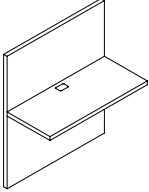
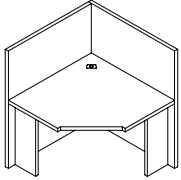
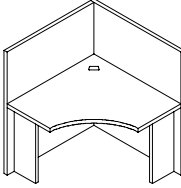
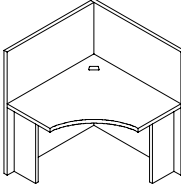
Description	Model Number	Overall Dimensions (in.)			Notes
		Depth	Width	Height	
Workstation Bridge 	xBOR-2436-0-GL1	24	36	50½	
	xBOR-2442-0-GL1	24	42	50½	
	xBOR-2448-0-GL1	24	48	50½	
	xBOR-2454-0-GL1	24	54	50½	
Includes 1 grommet - center					
Workstation Corner Bridge 	xBCRB-3636-0-GL1	36	36	50½	connects to 24" both sides
	xBCRB-4242-0-GL1	42	42	50½	connects to 24" both sides
Seated Diagonal 	xBCRB0D-3636-0-GL1	36	36	50½	connects to 24" both sides
Seated Radius 	xBCRB0D-4242-0-GL1	42	42	50½	connects to 24" both sides
Includes 1 grommet - center					
(note: no profile detail available) (note: worksurface removable for shipping)					

Description	Model Number	Overall Dimensions (in.)			Notes
		Depth	Width	Height	
Workstation Return Shell w/ Arc Transition along width	xR0A-2436- R -GL1	24	36	50½	
	xR0A-2442- R -GL1	24	42	50½	
	xR0A-2448- R -GL1	24	48	50½	
	xR0A-2454- R -GL1	24	54	50½	
	xR0A-2460- R -GL1	24	60	50½	
	xR0A-2466- R -GL1	24	66	50½	
	xR0A-2472- R -GL1	24	72	50½	

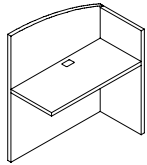

Includes 1 grommet - center
Specify **Left** or **Right** (seated)

(**Right** indicated)

(note: no profile detail available)
50½" high at high end, 41¼" high at low end

Workstation Bridge w/ Arc Transition	xB0A-2436- R -GL1	24	36	50½	
	xB0A-2442- R -GL1	24	42	50½	
	xB0A-2445- R -GL1	24	48	50½	
	xB0A-2454- R -GL1	24	54	50½	

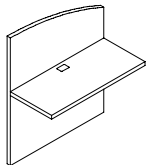

Includes 1 grommet - center
Specify **Left** or **Right** (seated)

(**Right** indicated)

(note: no profile detail available)
50½" high at high end, 41¼" high at low end

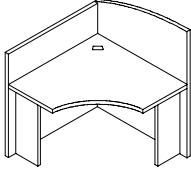
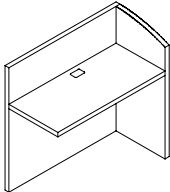
Description	Model Number	Overall Dimensions (in.)			Notes
		Depth	Width	Height	
Workstation Corner Bridge w/ Arc Transition	xBCAB0D-4242- R -GL1	42	42	50½	
					
Includes 1 grommet Specify Left or Right (seated)	(Right indicated)				(note: no profile detail available) (note: worksurface removable for shipping) 50½" high at high end, 41¼" high at low end
Gallery Return Shell w/ Arc Transition at end	xRAR-2436- R -GL1 xRAR-2442- R -GL1 xRAR-2448- R -GL1 xRAR-2454- R -GL1 xRAR-2460- R -GL1 xRAR-2466- R -GL1 xRAR-2474- R -GL1	24 24 24 24 24 24 24	36 42 48 54 60 66 72	41¼ 41¼ 41¼ 41¼ 41¼ 41¼ 41¼	
					
Includes 1 grommet - center Specify Left or Right (seated)	(Right indicated)				(note: no profile detail available) 41¼" high at high end, 37¾" high at low end

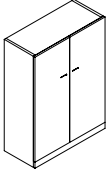
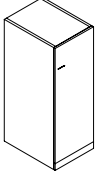
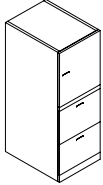
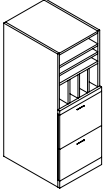
Description	Model Number	Overall Dimensions (in.)			Notes
		Depth	Width	Height	
Hinged Door Storage	xSH013-2530	25	30 $\frac{1}{8}$	50 $\frac{1}{2}$	
	xSH013-2536	25	36 $\frac{1}{8}$	50 $\frac{1}{2}$	
3 adjustable shelves					
Hinged Door Storage	xSH013-2516- R	25	16	50 $\frac{1}{2}$	
	xSH013-2519- R	25	19	50 $\frac{1}{2}$	
3 adjustable shelves		Specify Left or Right (right shown)			
Combination File/Storage	xSS0112-2516- R	25	16	50 $\frac{1}{2}$	storage above, 2 letter width files below
	xSS0112-2519- R	25	19	50 $\frac{1}{2}$	storage above, 2 legal width files below
	xSS0112-2530- R	25	30	50 $\frac{1}{2}$	storage above, 2- 30" w lateral files below
	xSS0112-2536- R	25	36	50 $\frac{1}{2}$	storage above, 2- 36" w lateral files below
1 adjustable shelf above		Specify Left or Right (right shown)			
Combination File/Sorter	xSY01D2-2516	25	16	50 $\frac{1}{2}$	2 letter width files below
	xSY01D2-2519	25	19	50 $\frac{1}{2}$	2 legal width files below
2 drawers below vertical/horizontal divider above		(note: all units on this page have finished backs and tops)			

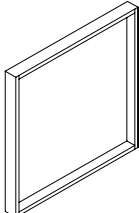
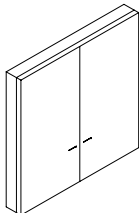
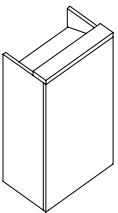
Description	Model Number	Overall Dimensions (in.)			Notes
		Depth	Width	Height	
Presentation Board 	xVBN-3648	4½	36	48	square edge (no profile detail)
	xVBN-4848	4½	48	48	square edge (no profile detail)
	xVBN-6048	4½	60	48	square edge (no profile detail)
	Dry Erase writing surface interior				
Hinged Door presentation Board 	xVBH-3648	6	36	48	square edge (no profile detail)
	xVBH-4848	6	48	48	square edge (no profile detail)
	xVBH-6048	6	60	48	square edge (no profile detail)
	_WC11-7362	6⅞	36	1½	top cap with edge profile
	_WC11-7482	6⅞	48⅞	1½	top cap with edge profile
	_WC11-7602	6⅞	60⅞	1½	top cap with edge profile
Fabric panels inside of doors Dry Erase writing surface interior					
Podium 	_VP-2030	20	30	42¾	
	_VP-2036	20	36	42¾	
Fixed shelf in kneespace					

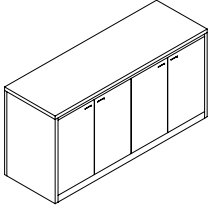
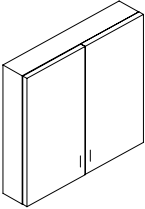
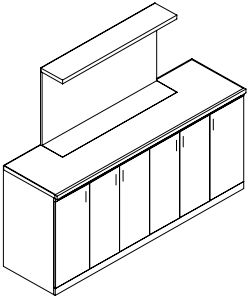
Description	Model Number	Overall Dimensions (in.)			Notes
		Depth	Width	Height	
	_C0V0L-2072-HHHH	20	72	36	2 bay, 4 hinged doors
	_C0V0L-2072-HHHHHH	20	84	36	3 bay, 6 hinged doors
	_C0V0L-2072-HHHHHH	20	96	36	3 bay, 6 hinged doors
	_C0V0L-2072-HHHH	24	72	36	2 bay, 4 hinged doors
	_C0V0L-2072-HHHHHH	24	84	36	3 bay, 6 hinged doors
	_C0V0L-2072-HHHHHH	24	96	36	3 bay, 6 hinged doors
	_VDH-4839	10	48	39	square edge (no profile detail)
	_VDH-5439	10	54	39	square edge (no profile detail)
	_VDH-6039	10	60	39	square edge (no profile detail)
	_VDH-6639	10	66	39	square edge (no profile detail)
	_WC11-11482	10 ⁷ / ₈	48	1½	top cap with edge profile
	_WC11-11542	10 ⁷ / ₈	54	1½	top cap with edge profile
	_WC11-11602	10 ⁷ / ₈	60	1½	top cap with edge profile
_WC11-11662	10 ⁷ / ₈	66	1½	top cap with edge profile	
Fabric panels inside of doors					
	_C0Y-2884	28	84	40	accommodates 42" plasma display
	_C0Y-2896	28	96	40	accommodates 54" plasma display
					2 full depth outside hinged door compartments 15" deep equipment shelves behind center doors with wire access to plasma display.
Plasma lift remote control included					

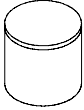
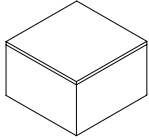
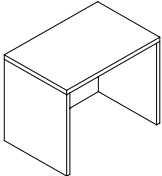
Description	Model Number	Overall Dimensions (in.)			Notes
		Depth	Width	Height	
Occasional Drum Table 	_TD-202018	19 $\frac{5}{8}$	19 $\frac{5}{8}$	18	
	_TD-262620	25 $\frac{5}{8}$	25 $\frac{5}{8}$	20	
	_TD-292920	29 $\frac{1}{8}$	29 $\frac{1}{8}$	20	
	_TD-292916	29 $\frac{1}{8}$	29 $\frac{1}{8}$	16	
Occasional Cube Table 	_TC-262620	26	26	20	
	_TC-213020	21	30	20	
	_TC-303020	30	30	20	
	_TC-404016	40	40	16	
Task Table 	xM0-2430	24	30	29 $\frac{1}{4}$	
	xM0-2436	24	36	29 $\frac{1}{4}$	
	xM0-2442	24	42	29 $\frac{1}{4}$	
	xMM-2430	24	30	29 $\frac{1}{4}$	
	xMM-2436	24	36	29 $\frac{1}{4}$	
	xMM-2442	24	42	29 $\frac{1}{4}$	

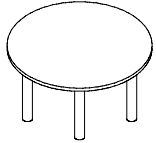
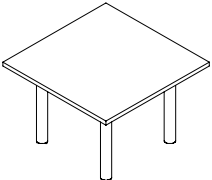
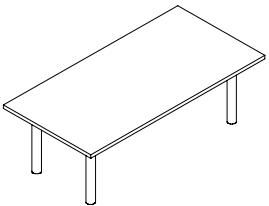
Description	Model Number	Overall Dimensions (in.)			Notes
		Depth	Width	Height	
Round Table Desk w/ Legs 	_TR4I-3636	36	36	29¼	
	_TR4I-4242	42	42	29¼	
	_TR4I-4848	48	48	29¼	
	_TR4I-5454	54	54	29¼	
	_TR4I-6060	60	60	29¼	
4- 4" legs Specify chrome or black legs					
Square Table w/ Legs 	_TS4I-3636	36	36	29¼	
	_TS4I-4242	42	42	29¼	
	_TS4I-4848	48	48	29¼	
	_TS4I-5454	54	54	29¼	
	_TS4I-6060	60	60	29¼	
4- 4" legs Specify chrome or black legs					
Rectangular Table w/ Legs 	_TS4I-3060	30	60	29¼	
	_TS4I-3066	30	66	29¼	
	_TS4I-3072	30	72	29¼	
	_TS4I-3666	36	66	29¼	
	_TS4I-3672	36	72	29¼	
	_TS4I-3678	36	78	29¼	
	_TS4I-3684	36	84	29¼	
	_TS4I-4284	42	84	29¼	
_TS4I-4290	42	90	29¼		
4- 4" legs Specify chrome or black legs					

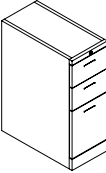
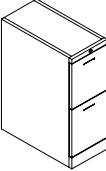
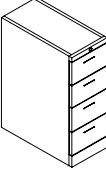
Description	Model Number	Overall Dimensions (in.)			Notes
		Depth	Width	Height	
Mini Pedestal -2 box, 1 file drawers	xPa03-209	18 ³ / ₈	9 ³ / ₈	27 ³ / ₄	
	xPa03-249	22 ³ / ₈	9 ³ / ₈	27 ³ / ₄	
	xPa03-309	28 ³ / ₄	9 ³ / ₈	27 ³ / ₄	
					
Includes lock Side to side filing only					top and back painted black
Mini Pedestal -2 file drawers	xPb03-209	18 ³ / ₈	9 ³ / ₈	27 ³ / ₄	
	xPb03-249	22 ³ / ₈	9 ³ / ₈	27 ³ / ₄	
	xPb03-309	28 ³ / ₄	9 ³ / ₈	27 ³ / ₄	
					
Includes lock Side to side filing only					top and back painted black
Mini Pedestal -4 box drawers	xPe03-209	18 ³ / ₈	9 ³ / ₈	27 ³ / ₄	
	xPe03-249	22 ³ / ₈	9 ³ / ₈	27 ³ / ₄	
	xPe03-309	28 ³ / ₄	9 ³ / ₈	27 ³ / ₄	
					
Includes lock					top and back painted black

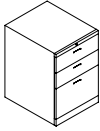
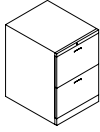
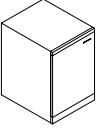
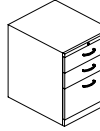
Description	Model Number	Overall Dimensions (in.)			Notes		
		Depth	Width	Height			
	Pedestal - 2 box, 1 file drawers	xPA03-1816	18 ³ / ₈	15 ³ / ₄	27 ³ / ₄	top and back painted black	
		xPA03-2216	22 ³ / ₈	15 ³ / ₄	27 ³ / ₄		
		xPA03-2816	27 ⁵ / ₈	15 ³ / ₄	27 ³ / ₄		
		xPC03-1819	18 ³ / ₈	18 ³ / ₄	27 ³ / ₄		
		xPC03-2219	22 ³ / ₈	18 ³ / ₄	27 ³ / ₄		
		xPC03-2819	27 ⁵ / ₈	18 ³ / ₄	27 ³ / ₄		
	xPC03-3419	33 ⁵ / ₈	18 ³ / ₄	27 ³ / ₄			
Includes lock							
	Pedestal - 2 file drawers	xPB03-1816	18 ³ / ₈	15 ³ / ₄	27 ³ / ₄	top and back painted black	
		xPB03-2216	22 ³ / ₈	15 ³ / ₄	27 ³ / ₄		
		xPB03-2819	27 ⁵ / ₈	15 ³ / ₄	27 ³ / ₄		
		xPD03-1819	18 ³ / ₈	18 ³ / ₄	27 ³ / ₄		
		xPD03-2219	22 ³ / ₈	18 ³ / ₄	27 ³ / ₄		
		xPD03-2819	27 ⁵ / ₈	18 ³ / ₄	27 ³ / ₄		
	xPD03-3419	33 ⁵ / ₈	18 ³ / ₄	27 ³ / ₄			
Includes lock							
	Pedestal - hinged door	xPH03-1816-L	18 ³ / ₈	15 ³ / ₄	27 ³ / ₄	top and back painted black	
		xPH03-2216-L	22 ³ / ₈	15 ³ / ₄	27 ³ / ₄		
		xPH03-2816-L	27 ⁵ / ₈	15 ³ / ₄	27 ³ / ₄		
		xPH03-1819-L	18 ³ / ₈	18 ³ / ₄	27 ³ / ₄		
		xPH03-2419-L	22 ³ / ₈	18 ³ / ₄	27 ³ / ₄		
		xPH03-2819-L	27 ⁵ / ₈	18 ³ / ₄	27 ³ / ₄		
Specify Left or Right hinged door (Left shown)							
	Mobile Pedestal-2 box,1 file Drawer	xPA05C-1816	18 ³ / ₈	15 ³ / ₄	27 ¹ / ₂	Finished 4 sides and top	
		xPA05C-2216	22 ³ / ₈	15 ³ / ₄	27 ¹ / ₂		
		xPC05C-1819	18 ³ / ₈	18 ³ / ₄	27 ¹ / ₂		
		xPC05C-2219	22 ³ / ₈	18 ³ / ₄	27 ¹ / ₂		
	Unit is on castors with 5th wheel to stabilize file drawer						

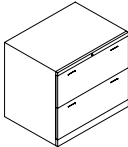
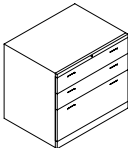
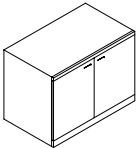
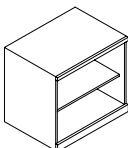
Description	Model Number	Overall Dimensions (in.)			Notes
		Depth	Width	Height	
Pedestal - Lateral File 	xPE03-1830	18 ³ / ₈	30	27 ³ / ₄	top and back painted black
	xPE03-2230	22 ³ / ₈	30	27 ³ / ₄	
	xPE03-2830	27 ⁵ / ₈	30	27 ³ / ₄	
	xPF03-1836	18 ³ / ₈	36	27 ³ / ₄	
	xPF03-2236	22 ³ / ₈	36	27 ³ / ₄	
	xPF03-2836	27 ⁵ / ₈	36	27 ³ / ₄	
Includes lock					
Pedestal - One Lateral File and Two Wide Box Drawers 	xPT03-1830	18 ³ / ₈	30	27 ³ / ₄	top and back painted black
	xPT03-2230	22 ³ / ₈	30	27 ³ / ₄	
	xPT03-2830	27 ⁵ / ₈	30	27 ³ / ₄	
	xPU03-1836	18 ³ / ₈	36	27 ³ / ₄	
	xPU03-2236	22 ³ / ₈	36	27 ³ / ₄	
	xPU03-2836	27 ⁵ / ₈	36	27 ³ / ₄	
Includes lock					
Pedestal - 2 hinged doors 	xPHH3-1830	18 ³ / ₈	30	27 ³ / ₄	top and back painted black
	xPHH3-2230	22 ³ / ₈	30	27 ³ / ₄	
	xPHH3-2830	27 ⁵ / ₈	30	27 ³ / ₄	
	xPHH3-1836	18 ³ / ₈	36	27 ³ / ₄	
	xPHH3-2236	22 ³ / ₈	36	27 ³ / ₄	
	xPHH3-2836	27 ⁵ / ₈	36	27 ³ / ₄	
One adjustable shelf					
Pedestal- bookshelf 	xPMM3-1830	18 ³ / ₈	30	27 ³ / ₄	top and back painted black
	xPMM3-2230	22 ³ / ₈	30	27 ³ / ₄	
	xPMM3-2830	27 ⁵ / ₈	30	27 ³ / ₄	
	xPNN3-1836	18 ³ / ₈	36	27 ³ / ₄	
	xPNN3-2236	22 ³ / ₈	36	27 ³ / ₄	
	xPNN3-2836	27 ⁵ / ₈	36	27 ³ / ₄	
One adjustable shelf					

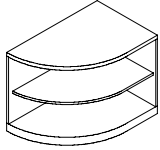
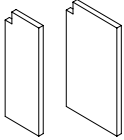
Description	Model Number	Overall Dimensions (in.)			Notes
		Depth	Width	Height	
Bend Pedestal with Shelf 	xSEI110L-1919	19¼	19¼	27¾	
	xSEI110L-1923	19¼	23¼	27¾	
	xSEI110L-1929	19¼	29¼	27¾	
	xSEI110L-1935	19¼	35¼	27¾	
	xSEI110L-1941	19¼	41¼	27¾	
	xSEI110L-2323	23¼	23¼	27¾	
	xSEI110L-2329	23¼	29¼	27¾	
	xSEI110L-2335	23¼	35¼	27¾	
	xSEI110L-2929	29¼	29¼	27¾	
	One fixed height shelf Specify Left or Right	(L eft indicated)			
Bracing Leg	xWL2N0S-10	10	1¼	27¾	
	xWL2N0S-15	15	1¼	27¾	
Bracing Leg 	xWL2N0A-9	9	1¼	27¾	
	xWL2N0A-12	12	1¼	27¾	
	xWL2N0A-15	15	1¼	27¾	
	xWL2N0A-18	18	1¼	27¾	
	xWL2N0A-21	21	1¼	27¾	
	xWL2N0A-24	24	1¼	27¾	
	xWL2N0A-27	27	1¼	27¾	
	xWL2N0A-30	30	1¼	27¾	

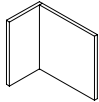
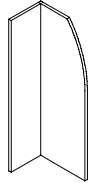
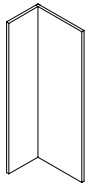
Description	Model Number	Overall Dimensions (in.)			Notes
		Depth	Width	Height	
"L" End Panel 	xWE2-1810- R	18 ³ / ₈	10	27 ³ / ₄	
	xWE2-2210- R	22 ³ / ₈	10	27 ³ / ₄	
	xWE2-2810- R	27 ⁵ / ₈	10	27 ³ / ₄	
	xWE2-3410- R	33 ⁵ / ₈	10	27 ³ / ₄	
Specify L or R (Right indicated)					
Workstation "L" End Panel w/ Arc Front	xWE20A-2517- R	25 ¹ / ₄	17	70 ¹ / ₂	
					
Specify L or R (Right indicated)					
Workstation "L" End Panel	xWE2-2117- R	21 ¹ / ₄	17	70 ¹ / ₂	
	xWE2-2517- R	25 ¹ / ₄	17	70 ¹ / ₂	
Specify L or R (Right indicated)					

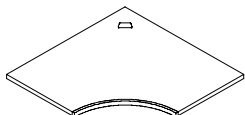
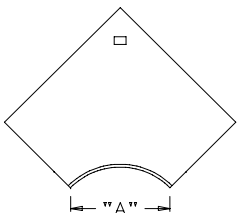
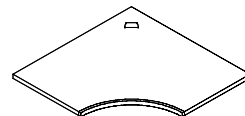
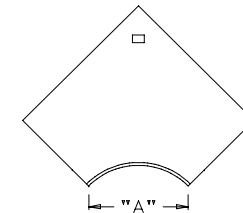
Description	Model Number	Overall Dimensions (in.)			Notes	
		Depth	Width	Height		
Corner Worksurface  	_BC0AT-3636-0-GL1	36	36	29¼	"A" = 22 ⁵ / ₈ " connects to 20" each side	
	_BC0BT-3636-0-GL1	36	36	29¼	"A" = 16 ⁷ / ₈ " connects to 24" each side	
	_BC0BT-4242-0-GL1	42	42	29¼	"A" = 31 ¹ / ₈ " connects to 20" each side	
	_BC0BT-4242-0-GL1	42	42	29¼	"A" = 25 ¹ / ₂ " connects to 24" each side	
	_BC0BT-3636-0-GL1	36	36	29¼	"A" = 20" connects to 20" on left and 24" on right	
	_BC0BT-3636-0-GL1	36	36	29¼	"A" = 20" connects to 24" on left and 20" on right	
	_BC0BT-4242-0-GL1	42	42	29¼	"A" = 28 ¹ / ₈ " connects to 20" on left and 24" on right	
	_BC0BT-4242-0-GL1	42	42	29¼	"A" = 28 ⁵ / ₈ " connects to 24" on left and 20" on right	
	Includes 1 grommet					
	Cove Corner Worksurface  	_BC0ATD-3636-0-GL1	36	36	29¼	"A" = 22 ⁵ / ₈ " connects to 20" each side
_BC0BTD-3636-0-GL1		36	36	29¼	"A" = 16 ⁷ / ₈ " connects to 24" each side	
_BC0ATD-4242-0-GL1		42	42	29¼	"A" = 31 ¹ / ₈ " connects to 20" each side	
_BC0BTD-4242-0-GL1		42	42	29¼	"A" = 25 ¹ / ₂ " connects to 24" each side	
_BC0DTD-3636-0-GL1		36	36	29¼	"A" = 20" connects to 20" on left and 24" on right	
_BC0ETD-3636-0-GL1		36	36	29¼	"A" = 20" connects to 24" on left and 20" on right	
_BC0DTD-4242-0-GL1		42	42	29¼	"A" = 28 ¹ / ₈ " connects to 20" on left and 24" on right	
_BC0ETD-4242-0-GL1		42	42	29¼	"A" = 28 ³ / ₈ " connects to 24" on left and 20" on right	
Includes 1 grommet						

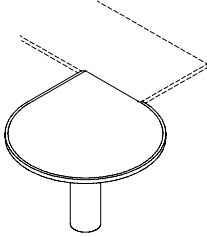
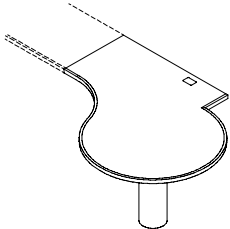
Description	Model Number	Overall Dimensions (in.)			Notes	
		Depth	Width	Height		
Droplet Runoff Worksurface	_DQUI-3636- R	36	36	29¼	4" post leg, attaches to 18" or longer worksurface	
	_DQUH-4242- R	42	42	29¼	6" post leg, attaches to 21" or longer worksurface	
	_DQUH-4848- R	48	48	29¼	6" post leg, attaches to 24" or longer worksurface	
						
<p>Connects to end of worksurface, desk, or credenza via counter profile Specify chrome or black leg Specify Left or Right (seated)</p>		(Right indicated)		Note: no grommet		
Eddy Runoff Worksurface	_DEUI-5145- R -GL1	51	45	29¼	36" diam. conference surface, 4" post leg	
	_DEUI-5148- R -GL1	51	48	29¼	36" diam. conference surface, 4" post leg	
	_DEUI-5163- R -GL1	51	63	29¼	36" diam. conference surface, 4" post leg	
	_DEUI-5166- R -GL1	51	66	29¼	36" diam. conference surface, 4" post leg	
	_DEUI-5172- R -GL1	51	72	29¼	36" diam. conference surface, 4" post leg	
	_DEUI-5175- R -GL1	51	75	29¼	36" diam. conference surface, 4" post leg	
	_DEUI-5184- R -GL1	51	84	29¼	36" diam. conference surface, 4" post leg	
	_DEUI-5187- R -GL1	51	87	29¼	36" diam. conference surface, 4" post leg	
						
	_DEUH-5754- R -GL1	57	54	29¼	42" diam. conference surface, 6" post leg	
	_DEUH-5757- R -GL1	57	57	29¼	42" diam. conference surface, 6" post leg	
	_DEUH-5772- R -GL1	57	72	29¼	42" diam. conference surface, 6" post leg	
	_DEUH-5775- R -GL1	57	75	29¼	42" diam. conference surface, 6" post leg	
	_DEUH-5781- R -GL1	57	81	29¼	42" diam. conference surface, 6" post leg	
	_DEUH-5784- R -GL1	57	84	29¼	42" diam. conference surface, 6" post leg	
_DEUH-5790- R -GL1	57	90	29¼	42" diam. conference surface, 6" post leg		
_DEUH-5793- R -GL1	57	93	29¼	42" diam. conference surface, 6" post leg		
<p>Connects to 24" deep straight, flow or cove worksurface Includes 1 grommet Specify chrome or black leg Specify Left or Right (seated)</p>		(Right indicated)				

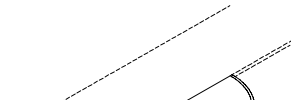
Description	Model Number	Overall Dimensions (in.)			Notes
		Depth	Width	Height	
Mini Peninsula Worksurface 	_WT11LA-1530	15	30	29¼	
	_WT11LA-1836	18	36	29¼	
	_WT11LA-2142	21	42	29¼	
	_WT11LA-2448	24	48	29¼	
	_WT11LA-3060	30	60	29¼	

Counter profiled straight edge
 Connects to profiled straight edges

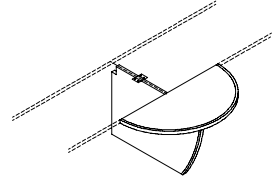
Mini Peninsula Worksurface w/ Extended Modesty 	_WT11LB-4236	42	36	29¼	
	_WT11LB-4542	45	42	29¼	
	_WT11LB-4848	48	48	29¼	
	_WT11LB-5460	54	60	29¼	

Counter profiled straight edge
 Connects to 24" or deeper straight
 Worksurfaces

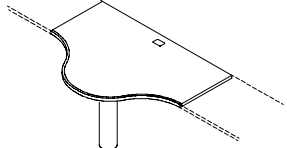
Swell Worksurface 	_WT11CI-4360-0-GL1	42½	60	29¼	4" post leg
	_WT11CI-4772-0-GL1	47¼	72	29¼	4" post leg

Connects to 24" deep worksurface at each side
 Includes 1 grommet - center
 Specify chrome or black leg

note: requires Perimeter Wall Mount Kit
 (see page 100)

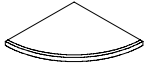
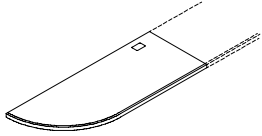
Description	Model Number	Overall Dimensions (in.)			Notes	
		Depth	Width	Height		
Bend Worksurface 	_WT11A-2020-L	20	20	1½		
	_WT11A-2024-L	20	24	1½		
	_WT11A-2030-L	20	30	1½		
	_WT11A-2036-L	20	36	1½		
	_WT11A-2042-L	20	42	1½		
	_WT11A-2424-L	24	24	1½		
	_WT11A-2430-L	24	30	1½		
	_WT11A-2436-L	24	36	1½		
	_WT11A-3030-L	30	30	1½		
	No grommet Specify Left or Right (Left indicated)					
Bend Worksurface 	_WT11A-2048-L-GL1	20	48	1½		
	_WT11A-2054-L-GL1	20	54	1½		
	_WT11A-2060-L-GL1	20	60	1½		
	_WT11A-2066-L-GL1	20	66	1½		
	_WT11A-2072-L-GL1	20	72	1½		
	_WT11A-2442-L-GL1	24	42	1½		
	_WT11A-2448-L-GL1	24	48	1½		
	_WT11A-2454-L-GL1	24	54	1½		
	_WT11A-2460-L-GL1	24	60	1½		
	_WT11A-2466-L-GL1	24	66	1½		
	_WT11A-2472-L-GL1	24	72	1½		
	_WT11A-3036-L-GL1	30	36	1½		
	_WT11A-3042-L-GL1	30	42	1½		
	_WT11A-3048-L-GL1	30	48	1½		
	_WT11A-3054-L-GL1	30	54	1½		
	_WT11A-3060-L-GL1	30	60	1½		
	_WT11A-3066-L-GL1	30	66	1½		
	_WT11A-3072-L-GL1	30	72	1½		
	Includes 1 grommet - square end (Left indicated)					

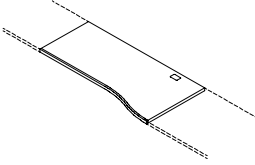
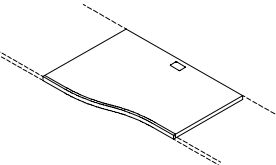
Description	Model Number	Overall Dimensions (in.)			Notes	
		Depth	Width	Height		
Flow Worksurface - W 	_WT11W-2430- R -GL1	24/20	30	1½		
	_WT11W-2436- R -GL1	24/20	36	1½		
	_WT11W-2442- R -GL1	24/20	42	1½		
	_WT11W-2448- R -GL1	24/20	48	1½		
	_WT11W-2454- R -GL1	24/20	54	1½		
	_WT11W-2460- R -GL1	24/20	60	1½		
	_WT11W-2466- R -GL1	24/20	66	1½		
	_WT11W-2472- R -GL1	24/20	72	1½		
	_WT11W-2478- R -GL1	24/20	78	1½		
	_WT11W-3030- R -GL1	30/24	30	1½		
	_WT11W-3036- R -GL1	30/24	36	1½		
	_WT11W-3042- R -GL1	30/24	42	1½		
	_WT11W-3048- R -GL1	30/24	48	1½		
	_WT11W-3054- R -GL1	30/24	54	1½		
	_WT11W-3060- R -GL1	30/24	60	1½		
	_WT11W-3066- R -GL1	30/24	66	1½		
	Transition at wide end	_WT11W-3072- R -GL1	30/24	72	1½	
	Includes 1 grommet	_WT11W-3078- R -GL1	30/24	78	1½	
	Specify L or R (seated)	(R ight indicated)				
	Flow Worksurface - M 	_WT11M-2430- L -GL1	24/20	30	1½	
_WT11M-2436- L -GL1		24/20	36	1½		
_WT11M-2442- L -GL1		24/20	42	1½		
_WT11M-2448- L -GL1		24/20	48	1½		
_WT11M-2454- L -GL1		24/20	54	1½		
_WT11M-2460- L -GL1		24/20	60	1½		
_WT11M-2466- L -GL1		24/20	66	1½		
_WT11M-2472- L -GL1		24/20	72	1½		
_WT11M-2478- L -GL1		24/20	78	1½		
_WT11M-3030- L -GL1		30/24	30	1½		
_WT11M-3036- L -GL1		30/24	36	1½		
_WT11M-3042- L -GL1		30/24	42	1½		
_WT11M-3048- L -GL1		30/24	48	1½		
_WT11M-3054- L -GL1		30/24	54	1½		
_WT11M-3060- L -GL1		30/24	60	1½		
_WT11M-3066- L -GL1		30/24	66	1½		
Transition at midspan		_WT11M-3072- L -GL1	30/24	72	1½	
Includes 1 grommet		_WT11M-3078- L -GL1	30/24	78	1½	
Specify L or R (seated)		(L eft indicated)				

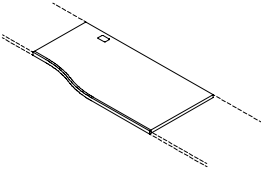
Description	Model Number	Overall Dimensions (in.)			Notes
		Depth	Width	Height	
Flow Worksurface - N 	_WT11N-2430-L-GL1	24/20	30	1½	
	_WT11N-2436-L-GL1	24/20	36	1½	
	_WT11N-2442-L-GL1	24/20	42	1½	
	_WT11N-2448-L-GL1	24/20	48	1½	
	_WT11N-2454-L-GL1	24/20	54	1½	
	_WT11N-2460-L-GL1	24/20	60	1½	
	_WT11N-2466-L-GL1	24/20	66	1½	
	_WT11N-2472-L-GL1	24/20	72	1½	
	_WT11N-2478-L-GL1	24/20	78	1½	
	_WT11N-3030-L-GL1	30/24	30	1½	
	_WT11N-3036-L-GL1	30/24	36	1½	
	_WT11N-3042-L-GL1	30/24	42	1½	
	_WT11N-3048-L-GL1	30/24	48	1½	
	_WT11N-3054-L-GL1	30/24	54	1½	
	_WT11N-3060-L-GL1	30/24	60	1½	
Transition at narrow end	_WT11N-3066-L-GL1	30/24	66	1½	
Includes 1 grommet	_WT11N-3072-L-GL1	30/24	72	1½	
Specify Left or Right	_WT11N-3078-L-GL1	30/24	78	1½	
	(Left indicated)				

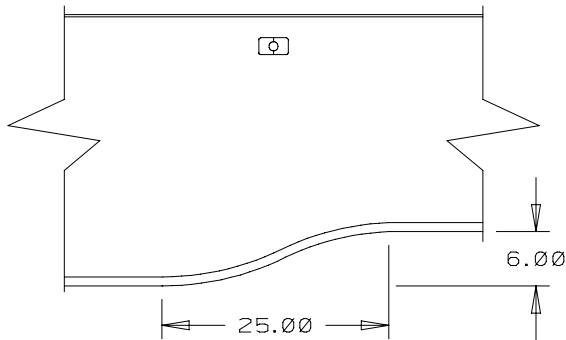

note: on all Flow worksurfaces, grommet location is directly opposite midpoint of transition

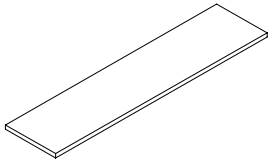
Description	Model Number	Overall Dimensions (in.)			Notes
		Depth	Width	Height	
Worksurface 	_WT11S-2016	20	16 $\frac{1}{8}$	1 $\frac{1}{2}$	
	_WT11S-2019	20	19 $\frac{1}{8}$	1 $\frac{1}{2}$	
	_WT11S-2030	20	30 $\frac{1}{8}$	1 $\frac{1}{2}$	
	_WT11S-2036	20	36 $\frac{1}{8}$	1 $\frac{1}{2}$	
	_WT11S-2042	20	42	1 $\frac{1}{2}$	
	_WT11S-2048	20	48	1 $\frac{1}{2}$	
	_WT11S-2054	20	54	1 $\frac{1}{2}$	
	_WT11S-2060	20	60	1 $\frac{1}{2}$	
	_WT11S-2066	20	66	1 $\frac{1}{2}$	
	_WT11S-2072	20	72	1 $\frac{1}{2}$	
	_WT11S-2078	20	78	1 $\frac{1}{2}$	
	_WT11S-2084	20	84	1 $\frac{1}{2}$	
	_WT11S-2090	20	90	1 $\frac{1}{2}$	
	_WT11S-2096	20	96	1 $\frac{1}{2}$	
	_WT11S-20108	20	108	1 $\frac{1}{2}$	
	_WT11S-20120	20	120	1 $\frac{1}{2}$	
	_WT11S-20132	20	132	1 $\frac{1}{2}$	
	_WT11S-20144	20	144	1 $\frac{1}{2}$	
	_WT11S-2416	24	16 $\frac{1}{8}$	1 $\frac{1}{2}$	
	_WT11S-2419	24	19 $\frac{1}{8}$	1 $\frac{1}{2}$	
	_WT11S-2430	24	30 $\frac{1}{8}$	1 $\frac{1}{2}$	
	_WT11S-2436	24	36 $\frac{1}{8}$	1 $\frac{1}{2}$	
	_WT11S-2442	24	42	1 $\frac{1}{2}$	
	_WT11S-2448	24	48	1 $\frac{1}{2}$	
	_WT11S-2454	24	54	1 $\frac{1}{2}$	
	_WT11S-2460	24	60	1 $\frac{1}{2}$	
	_WT11S-2466	24	66	1 $\frac{1}{2}$	
	_WT11S-2472	24	72	1 $\frac{1}{2}$	
	_WT11S-2478	24	78	1 $\frac{1}{2}$	
	_WT11S-2484	24	84	1 $\frac{1}{2}$	
	_WT11S-2490	24	90	1 $\frac{1}{2}$	
	_WT11S-2496	24	96	1 $\frac{1}{2}$	
	_WT11S-24108	24	108	1 $\frac{1}{2}$	
	_WT11S-24120	24	120	1 $\frac{1}{2}$	
	_WT11S-24132	24	132	1 $\frac{1}{2}$	
	_WT11S-24144	24	144	1 $\frac{1}{2}$	

Profile front edge only

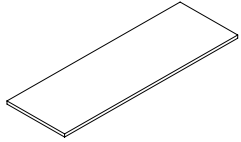
Description	Model Number	Overall Dimensions (in.)			Notes
		Depth	Width	Height	
Worksurface 	_WT11S-3016	30	16	1½	
	_WT11S-3019	30	19	1½	
	_WT11S-3030	30	30	1½	
	_WT11S-3036	30	36	1½	
	_WT11S-3042	30	42	1½	
	_WT11S-3048	30	48	1½	
	_WT11S-3054	30	54	1½	
	_WT11S-3060	30	60	1½	
	_WT11S-3066	30	66	1½	
	_WT11S-3072	30	72	1½	
	_WT11S-3078	30	78	1½	
	_WT11S-3084	30	84	1½	
	_WT11S-3090	30	90	1½	
	_WT11S-3096	30	96	1½	
	_WT11S-30108	30	108	1½	
	_WT11S-30120	30	120	1½	
_WT11S-30132	30	132	1½		
_WT11S-30144	30	144	1½		

Profile front edge only

Worksurface 	_WT12S-3060	30	60	1½	
	_WT12S-3066	30	66	1½	
	_WT12S-3072	30	72	1½	
	_WT12S-3078	30	78	1½	
	_WT12S-3084	30	84	1½	
	_WT12S-3090	30	90	1½	
	_WT12S-3096	30	96	1½	

Profile front and back edges

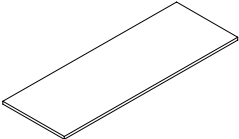
Description	Model Number	Overall Dimensions (in.)			Notes
		Depth	Width	Height	
Worksurface 	_WT11S-3660	36	60	1½	
	_WT11S-3666	36	66	1½	
	_WT11S-3672	36	72	1½	
	_WT11S-3678	36	78	1½	
	_WT11S-3684	36	84	1½	
	_WT11S-3690	36	90	1½	
	_WT11S-3696	36	96	1½	
	_WT11S-36108	36	108	1½	
	_WT11S-36120	36	120	1½	
	_WT11S-36132	36	132	1½	
	_WT11S-36144	36	144	1½	

Profile front edge only

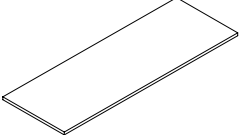
Worksurface 	_WT12S-3660	36	60	1½	
	_WT12S-3666	36	66	1½	
	_WT12S-3672	36	72	1½	
	_WT12S-3678	36	78	1½	
	_WT12S-3684	36	84	1½	
	_WT12S-3690	36	90	1½	
	_WT12S-3696	36	96	1½	

Profile front and back edges

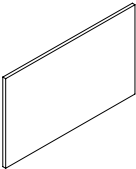
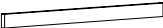
Description	Model Number	Overall Dimensions (in.)			Notes
		Depth	Width	Height	
Modesty Panel 	xWM2-13027	3/4	30	27 1/4	
	xWM2-13627	3/4	36	27 1/4	
	xWM2-14227	3/4	42	27 1/4	
	xWM2-14827	3/4	48	27 1/4	
	xWM2-15427	3/4	54	27 1/4	
	xWM2-16027	3/4	60	27 1/4	
	xWM2-16627	3/4	66	27 1/4	
	xWM2-17227	3/4	72	27 1/4	
	xWM2-17827	3/4	78	27 1/4	
	xWM2-18427	3/4	84	27 1/4	
	xWM2-19027	3/4	90	27 1/4	
	xWM2-19627	3/4	96	27 1/4	
	xWM2-110227	3/4	102	27 1/4	
	xWM2-110827	3/4	108	27 1/4	
	xWM2-111427	3/4	114	27 1/4	
	xWM2-112027	3/4	120	27 1/4	
	xWM2-112627	3/4	126	27 1/4	
	xWM2-113227	3/4	132	27 1/4	
	xWM2-113827	3/4	138	27 1/4	
xWM2-114427	3/4	144	27 1/4		
Keel 	xWM2-1483	3/4	48	3	
	xWM2-1543	3/4	54	3	
	xWM2-1603	3/4	60	3	
	xWM2-1663	3/4	66	3	
	xWM2-1723	3/4	72	3	
	xWM2-1783	3/4	78	3	
	xWM2-1843	3/4	84	3	
	xWM2-1903	3/4	90	3	
	xWM2-1963	3/4	96	3	
	xWM2-11023	3/4	102	3	
	xWM2-11083	3/4	108	3	
	xWM2-11143	3/4	114	3	
	xWM2-11203	3/4	120	3	
	xWM2-11263	3/4	126	3	
	xWM2-11323	3/4	132	3	
	xWM2-11383	3/4	138	3	
xWM2-11443	3/4	144	3		

(note: call factory for finished back pricing
on anchor and hi-rise storage units)

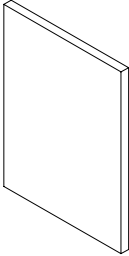
Description	Model Number	Overall Dimensions (in.)		
		Depth	Width	Height
End Panel 	_xWE2-2027	20	1¼	27¼
	_xWE2-2427	24	1¼	27¼
	_xWE2-3027	30	1¼	27¼
	_xWE2-3627	36	1¼	27¼
	_xWE2-4227	42	1¼	27¼
	_xWE2-4827	48	1¼	27¼
	_xWE2-5427	54	1¼	27¼
	_xWE2-6027	60	1¼	27¼
	_xWE2-6627	66	1¼	27¼
	_xWE2-7227	72	1¼	27¼
	_xWE2-7827	78	1¼	27¼
	_xWE2-8427	84	1¼	27¼
	_xWE2-9027	90	1¼	27¼
	_xWE2-9627	96	1¼	27¼

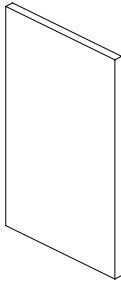
End panel 	_xWE2-2041	20	1¼	41¼
	_xWE2-2441	24	1¼	41¼
	_xWE2-3041	30	1¼	41¼
	_xWE2-3641	36	1¼	41¼
	_xWE2-4241	42	1¼	41¼
	_xWE2-4841	48	1¼	41¼
	_xWE2-5441	54	1¼	41¼
	_xWE2-6041	60	1¼	41¼
	_xWE2-6641	66	1¼	41¼
	_xWE2-7241	72	1¼	41¼
	_xWE2-7841	78	1¼	41¼
	_xWE2-8441	84	1¼	41¼
	_xWE2-9041	90	1¼	41¼
	_xWE2-9641	96	1¼	41¼

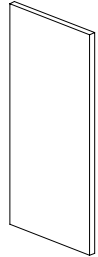
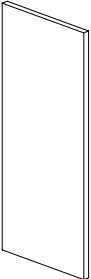
Description	Model Number	Overall Dimensions (in.)			Notes
		Depth	Width	Height	
End Panel 	_xWE2-2051	20	1 1/4	50 1/2	
	_xWE2-2451	24	1 1/4	50 1/2	
	_xWE2-3051	30	1 1/4	50 1/2	
	_xWE2-3651	36	1 1/4	50 1/2	
	_xWE2-4251	42	1 1/4	50 1/2	
	_xWE2-4851	48	1 1/4	50 1/2	
	_xWE2-5451	54	1 1/4	50 1/2	
	_xWE2-6051	60	1 1/4	50 1/2	
	_xWE2-6651	66	1 1/4	50 1/2	
	_xWE2-7251	72	1 1/4	50 1/2	
	_xWE2-7851	78	1 1/4	50 1/2	
	_xWE2-8451	84	1 1/4	50 1/2	
	_xWE2-9051	90	1 1/4	50 1/2	
	_xWE2-9651	96	1 1/4	50 1/2	
End Panel 	_xWE2-2071	20	1 1/4	70 1/2	
	_xWE2-2471	24	1 1/4	70 1/2	
	_xWE2-3071	30	1 1/4	70 1/2	
	_xWE2-3671	36	1 1/4	70 1/2	
	_xWE2-4271	42	1 1/4	70 1/2	
	_xWE2-4871	48	1 1/4	70 1/2	
	_xWE2-5471	54	1 1/4	70 1/2	
	_xWE2-6071	60	1 1/4	70 1/2	
Provided in sections up to 96" long					
End Panel 	_xWE2-2083	20	1 1/4	82 1/2	
	_xWE2-2483	24	1 1/4	82 1/2	
	_xWE2-3083	30	1 1/4	82 1/2	
	_xWE2-3683	36	1 1/4	82 1/2	
	_xWE2-4283	42	1 1/4	82 1/2	
	_xWE2-4883	48	1 1/4	82 1/2	
	_xWE2-5483	54	1 1/4	82 1/2	
	_xWE2-6083	60	1 1/4	82 1/2	

Description

Model Number

Overall Dimensions (in.)
Depth Width Height

Notes

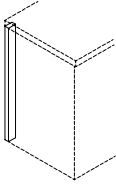
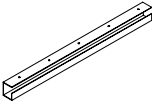
Description	Model Number	Overall Dimensions (in.)			Notes
		Depth	Width	Height	
Filler Strip	qWR3-27	13/16	1½	27¼	Used to fill rear overhang area at end of worksurface runs or on open back credenzas where overhang is considered objectionable.
					
Perimeter Wall Mount Kit	AMWB-size	3	12-96	4	Used to mount worksurfaces to perimeter 25 walls. Includes wire trough and foam edge per gasket.
					
Provided in sections up to 96" long					
Wall Mount End Cap	AMWB-CAP	3	4	4	Used to trim out exposed end of Wall Mount Kit when used with Eddy worksurface or other conditions where Wall Mount Kit end is visible.
